

Contents

0	Introduction	4
0.0.1	Gratitudes and acknowledgments.	5
0.1	A comprehensive list of theorems, examples, and questions	5
1	Tropical singular varieties and matroids	7
1.1	Introduction	8
1.2	Preliminaries	10
1.2.1	Tropical geometry and valuation fields	10
1.2.2	Change of coordinates and m -fold points	13
1.2.3	Lattice width and m -thick sets	15
	m -thickness Lemma	16
1.3	Matroids and their Bergman fans	18
1.3.1	Construction of the matroid of the Bergman fan	18
1.4	Examples and the Euler derivative	20
1.5	A lemma about concave functions	23
1.6	Formulation of main theorems	24
1.6.1	Influenced sets	25
1.6.2	Multiplicity of a tropical point in the intermediate sense	26
1.6.3	Exertion Theorems	26
	Exertion Theorem for edges	26
	Exertion Theorem for vertices	26
1.7	Intrinsic definition of a tropical m -fold point	27
1.8	Two combinatorial lemmata	28
1.8.1	Using the direction $(0, 1)$ or the direction $(1, 1)$	28
1.8.2	Using both directions $(0, 1)$ and $(1, 1)$	31
1.9	The proofs of the Exertion Theorems	33
1.9.1	Notation	33
1.9.2	The proof of Lemma 1.6.8	35
1.9.3	Proof of the Exertion theorem for edges	37
1.9.4	Proof of the Exertion theorem for vertices	38
1.10	Discussion	39
1.10.1	Tropical points of multiplicity m	40
2	Tropical approach to Nagata's conjecture in positive characteristic	41

2.1	Main Theorem and a discussion around Nagata's conjecture	41
2.1.1	Nagata's conjecture.	43
2.2	Preliminaries in tropical geometry	45
2.2.1	Influenced subsets in the Newton polytope	46
2.2.2	General position of points with respect to the Newton polygon	47
2.3	An estimate of a singular points' influence of the Newton polygon of a curve	48
2.3.1	Detropicalization Lemma	50
2.4	Degeneration of tropical points to a line.	51
2.5	Speculations destined to code theory	53
3	A guide to tropical modifications	55
3.1	Motivation and interpretations	56
3.1.1	Hyperbolic approach and moduli spaces	58
3.1.2	Berkovich spaces, non-standard analysis	59
3.2	Definitions and examples	61
3.2.1	Definition: tropical modification via the graphs of functions	61
3.2.2	Examples.	63
3.3	Some structural theorems about tropical modification	69
3.3.1	Tropical Weil reciprocity law and the tropical momentum map	70
3.3.2	Application of the tropical momentum to modifications.	73
3.3.3	Proof of the tropical Weil theorem	73
3.3.4	Difference between stable intersection and any other realizable intersection	74
3.3.5	Interpretation with chips	77
3.3.6	Digression: generalizations of the tropical momentum	79
3.4	Applications of a tropical modification as a method	80
3.4.1	Inflection points.	80
3.4.2	The category of tropical curves	80
3.4.3	Realization of a collection of lines and (4,d)-nets	80
3.4.4	A point of big multiplicity on a planar curve.	81
4	Tropical approach to legendrian curves in $\mathbb{C}P^3$	84
4.1	The contact structure on $\mathbb{C}P^3$	85
4.1.1	Contact form automorphisms	87
4.1.2	Macaulay2 code for the action of contactomorphism group on triplets of points	87
4.1.3	Curves on a hypersurface of degree two	89
4.1.4	Legendrian curves of degrees one and two	91
4.1.5	Legendrian cubics via Macaulay2	92
4.1.6	Legendrian cubics	94
4.1.7	Cubic surface containing the family of legendrian cubics	97
4.2	Tropicalization of legendrian curves	98
4.2.1	Tropical legendrian lines	98
4.2.2	Tropical legendrian cubic curves via Macaulay2	99
4.2.3	Code for producing tropical legendrian curves and their spanning surface	100
4.3	Tropical differential forms	106

4.3.1	Infinitesimal considerations via logarithmic Gauss derivative	106
4.3.2	Tropical legendrian lines and tropical forms	107
4.3.3	Tropical divisibility property for curves	108
4.3.4	Divisibility conditions for “line”-similar parts of the tropical rational legendrian cubics	109
4.4	Tropical differential forms in legendrian geometry	110
4.4.1	Integration on a tropical line	110
4.4.2	Tropical differential forms	110
4.4.3	Application of refined value of a tropical form to legendrian curves	111
A	Combinatorics of lattice width	112
A.1	An estimation of the volume of a body via its minimal lattice width	113
A.1.1	The approach by affinities decreasing the diameter	114
A.1.2	Estimation of λ_n	114
A.1.3	Estimation of δ_n	115
A.1.4	The approach by Mahler’s conjecture	115
A.2	Estimation of area in terms of lattice width	116
B	Applications of tropical geometry: economics	120
B.1	Theses about Economics.	121
B.2	Application of tropical geometry for auctions	122

Chapter 0

Introduction

*Was sich überhaupt sagen lässt, lässt sich klar sagen;
und wovon man nicht reden kann, darüber muss man schweigen.*

Ludwig Wittgenstein

An **outstanding dissertation** must contain a solution of some old interesting problem or it must develop a new beautiful area and prove some nice results there. Unfortunately, this is not quite the case here, hence I was curious – what is just a **good** ([99]) dissertation¹?

From the historical point of view, a dissertation (thesis) is a demonstration that a candidate can be a scientist. So, in mathematics it means that a candidate (me) can choose problems for research, have some success there, write the result clearly, relate it with other areas, do literature review, and write some explanatory (or pedagogical) texts, etc.

This thesis is written exactly from this point of view. Chapter 1 develops the tropical approach to m -fold points. Chapter 2 uses these results in relation with Nagata's conjecture. I chose this problem after two years struggling with the problem (Chapter 4) proposed to me by my advisor Grigory Mikhalkin. These chapters are extended versions of my articles [80, 81], I added more examples and survey the matroid part of the story. Also, Chapter 2 generalize many notions from the Chapter 1.

Chapter 3 is devoted to tropical modifications. It was an attempt to survey all existed interpretations, to give a lot of examples and to mention all the applications. Also we prove some technical statements, which simplify the life of a tropical geometer to some extent.

Chapter 4 is dedicated to a particular success in the problem, given me by my adviser, this chapter contains the study of the complex legendrian curve counting. Also we sketch some perspectives in the theory of tropical differential forms.

In Appendix A we survey the results concerning the following problem: what is the best constant in the estimate $\text{Volume}(D) \geq c\omega(D)^3$ where $\omega(D)$ is the minimal lattice width of a convex body $D \subset \mathbb{R}^3$. This question is related to Chapter 1 where we needed a similar result in \mathbb{R}^2 . In Appendix B we give a short survey of tropical economics. All the chapters can be read independently, though the Chapters 1,2,3 are deeply related and contain a lot of references hither and thither. Just after the subsection (following next) where I express the gratitude, the reader can find the list of all the important definitions, theorems, and questions in this thesis, with short annotations, see Section 0.1.

¹Latin, from from dis- "apart" + serere "to arrange words"

0.0.1 Gratitudes and acknowledgments.

Will be in three languages, as well as the introduction and the following section.

0.1 A comprehensive list of theorems, examples, and questions

Chapter 1 studies tropical m -fold points. For this occasion we survey existing definitions of a tropical m -fold point — Definition 1.1.2 (in extrinsic sense), Definition 1.7.4 (in intrinsic sense) — and give a new one — Definition 1.6.7 (in intermediate sense). We also prove that “extrinsic” implies “intermediate”, which implies “intrinsic” in its turn.

For an m -fold (in the intermediate sense) point on a tropical curve we find certain collection of faces of the dual subdivision of the Newton polygon, with total area of order m^2 . Such a “region of influence” is defined for any point, see Definitions 1.6.2, 1.6.4, 1.6.5. So, Exertion Theorems 1.6.11 (Figure 1.1(A)), 1.6.12 (Figure 1.1(B)) estimate the area of such a region of influence of an m -fold point from below, we say that this point *exerts* its influence to this region, whence the name of the theorems.

As shown in Chapter 2, these regions of influence may intersect but not too much (Corollary 2.2.18). We generalize the definitions of influenced sets to any dimension — Definition 2.2.12 and Example 2.2.13, Definitions 2.2.5, 2.2.7, 2.2.8, 2.2.10. The central theorem of this chapter, Theorem 2.1.5, estimates the area of the Newton polygon of a curve, passing through generic points with prescribed multiplicities. Two advantages of this theorem are the following. We consider an arbitrary toric variety, i.e. the Newton polygon of a curve is arbitrary, and the ground field can be any infinite field, or even finite, but big enough.

In Chapter 3 we try to survey all what is known about tropical modifications. Theorem 3.3.10 gives a tropical version of the Weil reciprocity law, and it is equivalent to tropical Menelaus Theorem (Lemma 3.3.14, Proposition 3.3.16). As an application, see Example 3.2.17. We also study the following question: what is the “true” intersection (i.e. coming as a degeneration of the intersection) of two tropical varieties with non-transversal intersection. We introduce a new restriction, Theorem 3.3.28 (see Example 3.3.27), and define an order \prec on the divisors, Definition 3.3.25. In short, a divisor, realizable as an intersection, must be less than the divisor of the stable intersection. Definition 3.3.35 provides a generalization of the tropical momentum for tropical varieties of higher dimensions.

Chapter 4 is devoted to tropical legendrian curves. We mention that $\mathrm{Sp}(4)$ is generically three-transitive (Lemma 4.1.10), that allows us to find (using Macaulay2 and Mathematica, because the computations are enormous) concrete examples of tropical legendrian cubics (Section 4.2 contains many pictures and a lot of code). Theorem 4.1.13 provides the list of all the possible types of algebraic legendrian curves on a quadric surface. Theorem 4.1.17 describes the set of rational legendrian cubics through three generic points in $\mathbb{C}P^3$ — a linear family. Therefore, the number of rational legendrian cubics through three generic points and one generic line is three.

In Proposition 4.1.15 we observe a nice divisibility property (Definition 4.2.3). This property with the tropical genedrian tangency property (Definition 4.3.5) completely characterize tropical legendrian lines. In fact, that was the starting point of the whole project — a wish to establish this properties for all tropical legendrian curves. We have only partial success. Theorem 4.3.8 states that the tropical legendrian divisibility property holds for rational legendrian curves of any degree,

as long as the parametrization of the curve in \mathbb{C}^3 is given by three polynomials. Theorem 4.3.10 tells that the tropical legendrian divisibility property holds for legendrian rational cubics. The proof of the theorem that this property holds in general is only sketched as well as the theory of tropical differential forms, see Sections 4.4.1, 4.4.3. In Question 21 we conjecture that the similar statements about forms hold in all tropically-related contexts.

In Appendix A we calculate the best known constant in the inequality $\text{Volume}(D) \geq c\omega(D)^3$ for a convex compact set $D \subset \mathbb{R}^3$, Proposition A.1.10. In Appendix B we explain how transversal tropical intersection helps the Bank of England (Proposition B.2.2).

The thesis contains open problems, we call them “questions”. We list here some of them. Question 23: for a given convex compact set $D \subset \mathbb{R}^3$ we can try to apply an affine linear transformation, preserving the volume and decreasing the diameter of D . So, what is the minimal diameter that we can obtain, in terms of $\text{Volume}(D)$?

Questions 22, 12, 9 are asking for a right analog of the Newton polytope for two dimensional surfaces in \mathbb{C}^4 , and how to extend various tropical notions to it. Question 20 proposes a hypothesis about the number of rational legendrian curves of degree d through d points and one line. Question 18 offers to finish the classification of the legendrian curves on a quadric surface. This could help to find enumerative answers about special types of legendrian curves in $\mathbb{C}P^3$.

If it is always possible to choose such lifts of two tropical curves with non-transversal intersection such that all their local intersection in one connected component concentrates at one point, where we have a tangency (Question 14)? In Question 13 we ask for reformulation of these problems with realizable intersection via objects on an abstract tropical variety. Indeed, we may suppose that both varieties are given as zero sets of polynomials. Deformations of the coefficients, and the corresponding contractions should be written in terms of only one variety. This would lead to a notion of “normal” bundle of an embedded tropical variety.

Question 8 asks to which extent the definition of \mathbb{K} -extrinsic multiple point on a tropical curve depends on the field \mathbb{K} . In Question 8 (totally unrelated to all the other topics) we are interested in generalizations of some nice integration properties for concave functions in one variable. In Questions 2, 3 we are curious about some combinatorial properties of lattice polygons, these properties trivially follows in the algebraic approach, but it would be intriguing to prove them directly.

Chapter 1

Tropical singular varieties and matroids

*“There is no such thing as a good influence, Mr. Gray.
All influence is immoral – immoral from the scientific point of view.”*
“Why?”
*“Because to influence a person is to give him one’s own soul.
He does not think his natural thoughts, or burn with his natural passions.
His virtues are not real to him.”*
The picture of Dorian Gray.

This chapter is an extended version of my article “The Newton polygon of a planar singular curve and its subdivision” ([81]). Here I clarify the connection of the tropical singularities with matroid theory, speculate about possible extensions, and survey the current state of art.

We give several definitions of a tropical singular point of multiplicity m and discuss the differences. Also, the content of this chapter is deeply related with Chapter 3, where the latter concerns the singularities.

In a sense, the roots of the interest to tropical singularities can be found in the study of discriminants and resultants, see the monograph [64](Gelfand, Kapranov, Zelevinsky). Indeed, the discriminant of a polynomial f tells us what are the constraints for the coefficients of f if the curve defined by $\{f = 0\}$ has points of multiplicity at least two. Here we study the tropical side of this story – what are the constraints for the *valuations* of these coefficients.

Namely, we consider an algebraic curve C defined over a valuation field by an equation $F(x, y) = 0$. Valuations of the coefficients of F define a subdivision of the Newton polygon Δ of the curve C .

A point p is *of multiplicity m* (or is an m -fold point) on C if the lowest term in the Taylor expansion of F at p has degree m . Initial interest in tropical points of higher multiplicity was caused by Nagata’s conjecture. This conjecture proposes the estimate $d \geq m\sqrt{n}$ for the minimal degree d of a curve which has $n > 9$ points of multiplicity m in general position. Motivated by this conjecture, we study the following question: how do the points of multiplicity m on C influence the above subdivision of Δ ? This chapter is devoted to the case of one m -fold point, whereas Chapter 2 concerns the case of several m -fold points.

If a given point p is of multiplicity m on C , then the coefficients of F are subject to certain *linear* constraints. The full description of these constraints is obtained and studied in [50, 51, 52]; that approach can be extended to the finite characteristic and p -adic cases [154].

However, it is much harder to grasp the influence of a singular point on the actual tropical picture. Our aim was to obtain somewhat similar to the geometrico-combinatorial properties of the matroid in the case of two-fold point on curves and surfaces [106, 107, 108], inflection points [33], and cusps [63].

We are mostly interested in how these constraints can be *visualized* in the above subdivision of Δ . We find a distinguished collection of faces of the above subdivision, with total area at least $\frac{3}{8}m^2$. The union of these faces can be considered to be the “region of influence” of the singular point p in the subdivision of Δ .

We also study the following question: given a tropical curve, how can we decide if it comes as a tropicalization of a curve with m -fold point? We discuss three different definitions of a tropical point of multiplicity m in relation with that. For the direction “from tropical geometry to algebraic geometry” see also patchworking of tropical singular points ([151]). Some obstructions for the realizability of singular points are discussed in Chapter 3, see Section 3.3.4 and examples there.

A reader is supposed to be familiar with tropical geometry. As a good introduction to a kind of tropical geometry I need, let me propose you [29] (see also [77, 78, 101, 116, 120, 119]). Basic notions about matroid theory and Bergman fans can be found in [10, 129].

1.1 Introduction

Fix a non-empty finite subset $\mathcal{A} \subset \mathbb{Z}^2$ and any valuation field \mathbb{K} . We consider a curve C given by an equation $F(x, y) = 0$, where

$$F(x, y) = \sum_{(i,j) \in \mathcal{A}} a_{ij} x^i y^j, \quad a_{ij} \in \mathbb{K}^*. \quad (1.1)$$

Suppose that we know only the valuations of the coefficients of the polynomial $F(x, y)$. Is it possible to extract any meaningful information from this knowledge? Unexpectedly, many geometric properties of C are visible from such a viewpoint.

The *Newton polygon* $\Delta = \Delta(\mathcal{A})$ of the curve C is the convex hull of \mathcal{A} in \mathbb{R}^2 . The *extended Newton polyhedron* $\tilde{\mathcal{A}}$ of the curve C is the convex hull of the set $\{((i, j), s) \in \mathbb{R}^2 \times \mathbb{R} \mid (i, j) \in \mathcal{A}, s \leq \text{val}(a_{ij})\}$. Projection of all the faces of $\tilde{\mathcal{A}}$ along \mathbb{R} induces a *subdivision* of Δ . Note that the valuations of the coefficients of F completely determine $\tilde{\mathcal{A}}$ and this subdivision of Δ .

By definition, the non-Archimedean amoeba of C is $\text{Val}(C) = \{(\text{val}(x), \text{val}(y)) \mid (x, y) \in C\}$. Also, we define the tropical curve $\text{Trop}(C)$ as the set of non-smooth points of the function $\max_{(i,j) \in \mathcal{A}} (iX + jY + \text{val}(a_{ij}))$. It is known that $\text{Val}(C) \subset \text{Trop}(C)$. Furthermore, $\text{Trop}(C)$ is a graph which is combinatorially dual to the subdivision of Δ (described above). In particular, each vertex V of $\text{Trop}(C)$ corresponds to a face $d(V)$ of this subdivision of Δ .

Fix a point $p = (p_1, p_2) \in (\mathbb{K}^*)^2$. Define $P = \text{Val}(p) = (\text{val}(p_1), \text{val}(p_2))$. We consider a curve C given by (1.1) such that p is of multiplicity m on C . In such a case, the coefficients a_{ij} of C satisfy a certain set of $\frac{m(m+1)}{2}$ linear constraints. In turn, the constraints for the numbers $\text{val}(a_{ij})$ manifest themselves via the fact that the subdivision of Δ enjoys very special properties.

In particular, there is a certain collection $\mathfrak{J}(P)$ of vertices of $\text{Trop}(C)$ (Figure 1.1, lower row). We estimate the total area of the faces in the subdivision of Δ dual to the vertices in $\mathfrak{J}(P)$ (Figure 1.1, upper row). Namely, if the minimal lattice width of Δ is at least m , then the following inequality

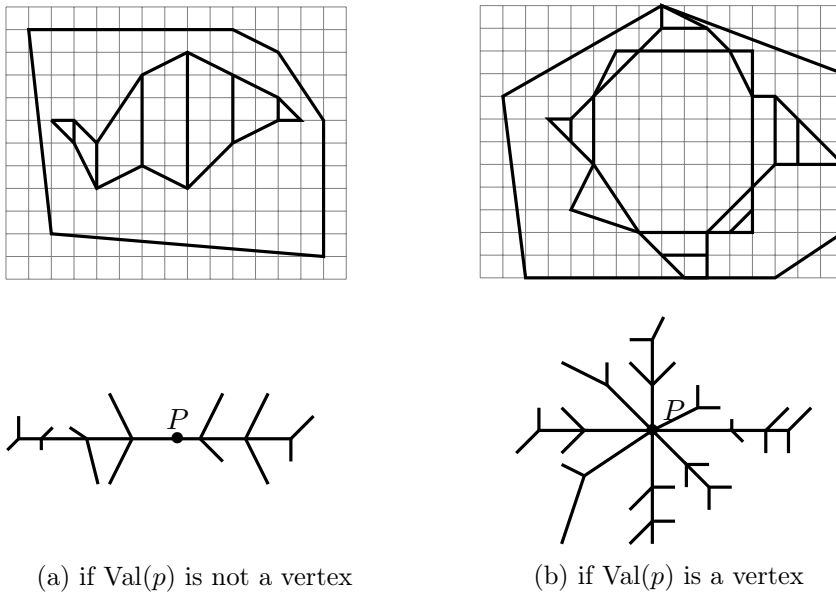

(a) if $\text{Val}(p)$ is not a vertex

(b) if $\text{Val}(p)$ is a vertex

Figure 1.1: If P is not a vertex of $\text{Trop}(C)$ (left column), then the collection $\mathfrak{J}(P)$ of vertices consists of all the vertices of $\text{Trop}(C)$ lying on the extension of the edge through P . If P is a vertex of $\text{Trop}(C)$ (right column), then we take the vertices on the extensions of all the edges through P . In each case the corresponding set of faces of the subdivision of Δ , the “region of influence” of P , is drawn at the top. The sum of the areas of the faces in (1.2) is at least $\frac{1}{2}m^2$ in (A) and at least $\frac{3}{8}m^2$ in (B).

holds:

$$\sum_{V \in \mathfrak{J}(P)} \text{area}(d(V)) \geq cm^2. \quad (1.2)$$

If P is not a vertex of $\text{Trop}(C)$, then (1.2) holds with $c = \frac{1}{2}$; if P is a vertex of $\text{Trop}(C)$, then (1.2) holds with $c = \frac{3}{8}$, see Lemma 1.6.8, Theorems 1.6.11, 1.6.12 in Section 1.6 for more details.

Remark 1.1.1. Let us fix points p_1, p_2, \dots, p_n in general position. Suppose that C passes through them. In Chapter 2 we prove that in this case each vertex of $\text{Trop}(C)$ belongs to at most two sets $\mathfrak{J}(P_i)$, i.e., for indices $i_1 < i_2 < i_3$ we have $\mathfrak{J}(P_{i_1}) \cap \mathfrak{J}(P_{i_2}) \cap \mathfrak{J}(P_{i_3}) = \emptyset$.

Definition 1.1.2 ([52, 106]). The multiplicity of a point P on a tropical curve H is at least m in the \mathbb{K} -extrinsic sense if there exists an algebraic curve $H' \subset (\mathbb{K}^*)^2$ and a point $p \in H'$ of multiplicity m such that $\text{Trop}(H') = H, \text{Val}(p) = P$.

This definition is extrinsic because it involves other objects besides H . We find new necessary intrinsic conditions (in terms of the subdivision of Δ) for the presence of an m -fold point on C . We give two other definitions (Def. 1.7.4, Def. 1.6.7) of a tropical singular point and compare them in Section 1.10.1.

1.2 Preliminaries

1.2.1 Tropical geometry and valuation fields

Let \mathbb{T} denote $\mathbb{R} \cup \{-\infty\}$. \mathbb{T} is usually called *the tropical semi-ring*. Let \mathbb{K} be any valuation field, i.e., a field equipped with a *valuation map* $\text{val} : \mathbb{K} \rightarrow \mathbb{T}$, where this map val possesses the following properties:

- $\text{val}(ab) = \text{val}(a) + \text{val}(b)$,
- $\text{val}(a + b) \leq \max(\text{val}(a), \text{val}(b))$,
- $\text{val}(0) = -\infty$.

Example 1.2.1. Let \mathbb{F} be an arbitrary (possibly finite) field. An example of a valuation field is the field $\mathbb{F}\{\{t\}\}$ of generalized Puiseux series. Namely,

$$\mathbb{F}\{\{t\}\} = \left\{ \sum_{\alpha \in I} c_\alpha t^\alpha \mid c_\alpha \in \mathbb{F}, I \subset \mathbb{R} \right\},$$

where t is a formal variable and I is a well-ordered set, i.e., each of its nonempty subsets has a least element. The valuation map $\text{val} : \mathbb{K} \rightarrow \mathbb{T}$ is defined by the rule

$$\text{val}\left(\sum_{\alpha \in I} c_\alpha t^\alpha\right) := -\min_{\alpha \in I} \{\alpha \mid c_\alpha \neq 0\}, \text{val}(0) := -\infty.$$

Different constructions of Puiseux series and their properties are listed in [109, 146].

Remark 1.2.2. It follows from the axioms of the valuation map that if $a_1 + a_2 + \dots + a_n = 0$, $a_i \in \mathbb{K}^*$, then the maximum among $\text{val}(a_i)$, $i = 1, \dots, n$ is attained at least twice.

Example 1.2.3. Suppose that $\mathbb{K} = \mathbb{C}\{\{t\}\}$ and all the coefficients $a_{ij} \in \mathbb{K}^*$ in (1.1) are convergent series in t for t close to zero. Then, specializing t to be $t_k \in \mathbb{C}$ close to zero, we obtain a family of complex curves C_{t_k} defined by the equations $\sum_{(i,j) \in \mathcal{A}} a_{ij}(t_k) x^i y^j = 0$. Note that the valuation $\text{val}\left(\sum_{\alpha \in I} c_\alpha t^\alpha\right) = -\min_{\alpha \in I} \{\alpha \mid c_\alpha \neq 0\}$ is a measure of the asymptotic behavior of a_{ij} as t_k tends to 0, i.e., $a_{ij}(t_k) \sim t_k^{-\text{val}(a_{ij})}$.

The combinatorics of the extended Newton polyhedron reflects some asymptotically visible properties of a generic member of the family $\{C_{t_k}\}$. In such a way, real algebraic curves with a prescribed topology can be constructed; see Viro's patchworking method. See also [33], where the curves with a lot of inflection points are constructed by Viro's method.

Definition 1.2.4 ([56]). *The non-Archimedean amoeba* $\text{Val}(C) \subset \mathbb{T}^2$ of an algebraic curve $C \subset \mathbb{K}^2$ is the image of C under the map val applied coordinate-wise.

Now we recall some basic notions of tropical geometry.

Definition 1.2.5. For the given $F(x, y) = \sum_{(i,j) \in \mathcal{A}} a_{ij} x^i y^j$, we define

$$\text{Trop}(F)(X, Y) = \max_{(i,j) \in \mathcal{A}} (iX + jY + \text{val}(a_{ij})). \quad (1.3)$$

We use the letters x, y for variables in \mathbb{K} , and we use X, Y for the corresponding variables in \mathbb{T} . Fix a finite subset $\mathcal{A} \subset \mathbb{Z}^2$. Let us consider a curve C given by (1.1).

Definition 1.2.6. Let $\text{Trop}(C) \subset \mathbb{T}^2$ be the set of points where $\text{Trop}(F)$ is not smooth, that is, the set of points where the maximum in (1.3) is attained at least twice.

It is clear that $\text{Trop}(C)$ is a planar graph, whose edges are straight.

Remark 1.2.7. We have $\text{Val}(C) \subset \text{Trop}(C)$ because if $F(x, y) = 0$, then the maximum among $\text{val}(a_{ij} x^i y^j)$ must be attained at least twice (Remark 1.2.2). If \mathbb{K} is algebraically closed and the image of val contains \mathbb{Q} , then $\overline{\text{Val}(C)} = \text{Trop}(C)$ (cf. [56], Theorem 2.1.1).

To the curve C , we associate a subdivision of its Newton polygon $\Delta = \text{ConvHull}(\mathcal{A})$ by the following procedure. Consider *the extended Newton polyhedron* ([56])

$$\tilde{\mathcal{A}} = \text{ConvHull}\left(\bigcup\{(i, j, x) \mid (i, j) \in \mathcal{A}, x \leq \text{val}(a_{ij})\}\right) \subset \mathbb{R}^3.$$

The projection of the edges of $\tilde{\mathcal{A}}$ to the first two coordinates gives us a subdivision of Δ . Hence the curve C produces the tropical curve $\text{Trop}(C)$ and the subdivision of Δ .

Proposition 1.2.8. This subdivision is dual to $\text{Trop}(C)$ in the following sense:

- each vertex Q of $\text{Trop}(C)$ corresponds to some face $d(Q)$ of the subdivision of Δ ;

- each edge E of $\text{Trop}(C)$ corresponds to some edge $d(E)$ in the subdivision of Δ , and the direction of the edge $d(E)$ is perpendicular to the direction of E ;
- if a vertex $Q \in \text{Trop}(C)$ is an end of an edge $E \subset \text{Trop}(C)$, then $d(Q)$ contains $d(E)$;
- each vertex of \tilde{A} corresponds to a connected component of $\mathbb{T}^2 \setminus \text{Trop}(C)$.

Proof. This proposition follows from Def. 1.2.6. □

Example 1.2.10 illustrates this proposition. See Figure 1.2 for an example of the above duality. Also, parts of tropical curves and the corresponding parts of the dual subdivisions are shown in Figure 1.1.

Definition 1.2.9. Suppose that $\text{Trop}(F)$ is equal to $i_1X + j_1Y + \text{val}(a_{i_1j_1})$ on one side of an edge $E \subset \text{Trop}(C)$ and to $i_2X + j_2Y + \text{val}(a_{i_2j_2})$ on the other side of E . Therefore E is locally defined by the equation $(i_1 - i_2)X + (j_1 - j_2)Y + (\text{val}(a_{i_1j_1}) - \text{val}(a_{i_2j_2})) = 0$. In this case the endpoints of $d(E)$ are $(i_1, j_1), (i_2, j_2)$, and, by definition, the *weight* of E is equal to the lattice length of $d(E)$, which is $\text{gcd}(i_1 - i_2, j_1 - j_2)$ by definition.

Example 1.2.10. Consider a curve C' defined by the equation $G(x, y) = 0$, where

$$G(x, y) = t^{-3}xy^3 - (3t^{-3} + t^{-2})xy^2 + (3t^{-3} + 2t^{-2} - 2t^{-1})xy - (t^{-3} + t^{-2} - 2t^{-1} - 3t^2)x + t^{-2}x^2y^2 - (2t^{-2} - t^{-1})x^2y + (t^{-2} - t^{-1} - 3t^2)x^2 + t^{-1}y - (t^{-1} + t^2) + t^2x^3.$$

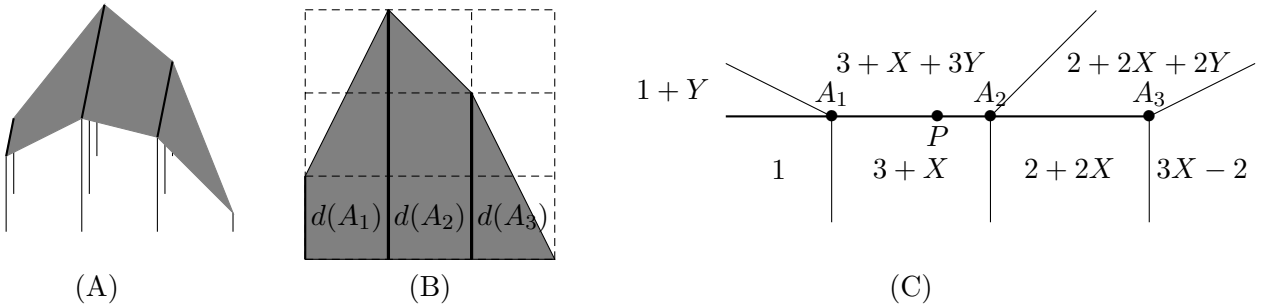

Figure 1.2: The extended Newton polyhedron \tilde{A} of the curve C' (Example 1.2.10) is drawn in (A). The projection of its faces gives us the subdivision of the Newton polygon of C' ; see (B). The tropical curve $\text{Trop}(C')$ is drawn in (C). The vertices A_1, A_2, A_3 have coordinates $(-2, 0), (1, 0), (4, 0)$. The edge A_1A_2 has weight 3, while the edge A_2A_3 has weight 2. The point P is $(0, 0) = \text{Val}((1, 1))$.

The curve $\text{Trop}(C')$ is equal to the set of non-smooth points of the function

$$\text{Trop}(F) = \max(3 + X + 3Y, 3 + X + 2Y, 3 + X + Y, 3 + X, 2 + 2X + 2Y, 2 + 2X + Y, 2 + 2X, 1 + Y, 1, 3X - 2).$$

The plane is divided by $\text{Trop}(C')$ into regions corresponding to the vertices of $\tilde{\mathcal{A}}$. In Figure 1.2, the value of $\text{Trop}(F)(X, Y)$ is written on each region. For example, $3X - 2$ corresponds to the vertex $(3, 0, -2)$ of $\tilde{\mathcal{A}}$.

A *tropical curve* $H \subset \mathbb{T}^2$ is the non-smooth locus of a function (1.3) with finite $\mathcal{A} \subset \mathbb{Z}^2$.

Remark 1.2.11. The tropical curves defined by the equations $\max(x, y, 0)$ and $\max(2x, 2y, 0)$ coincide as sets, but the weights of the edges of the second curve are equal to 2, whereas for the first curve the weights of its edges are equal to 1.

Given a tropical curve H as a subset of \mathbb{T}^2 with weights on its edges (as we always assume in this paper), we can construct an equation, defining H . Then we construct the extended Newton polyhedron for H , using the same formula as for algebraic curves. The function defining H is not unique, therefore the extended Newton polyhedron for H is defined up to a translation.

Remark 1.2.12. When we pass from the set $\{(i, j, \text{val}(a_{ij}))\}$ to $\tilde{\mathcal{A}}$, some information is lost. Nevertheless, we do not suppose that all the points $\{(i, j, \text{val}(a_{ij}))\}$ belong to the boundary of $\tilde{\mathcal{A}}$.

The reader should be familiar with the notions mentioned above, or is kindly requested to refer to [29, 78, 102].

1.2.2 Change of coordinates and m -fold points

Definition 1.2.13. If the lowest term in the Taylor expansion of F at a point p has degree m , then $m = \mu_p(C)$ is called the *multiplicity* of p . The point p is called an m -fold point or a point of multiplicity m .

Another way to say the same thing is to define $\mu_p(C)$ for $p = (p_1, p_2)$ as the maximal m such that the polynomial F belongs to the m -th power of the ideal of the point p , i.e., $F \in \langle x - p_1, y - p_2 \rangle^m$ in the local ring of the point p .

Example 1.2.14. The condition for a point p to be of multiplicity one on C means that $p \in C$. Multiplicity greater than one implies that p is a singular point of C .

Example 1.2.15. The point $(0, 0)$ is a point of multiplicity two for the curve defined by the equation $x^2 - y^3 = 0$.

Example 1.2.16. Consider a curve C' of degree d given by an equation

$$G(x, y) = \sum b_{ij} x^i y^j, 0 \leq i, j, i + j \leq d.$$

The point $(0, 0)$ is of multiplicity at least m on the curve C' if and only if $b_{ij} = 0$ for all i, j with $i + j < m$. As a consequence, for a given point $p \in (\mathbb{K}^*)^2$, the condition that $\mu_p(C') \geq m$ can be rewritten as a certain system of $\frac{m(m+1)}{2}$ linear equations in the coefficients $\{b_{ij}\}$ of G .

If the characteristic of \mathbb{K} is zero, then the above definition is equivalent to the following one.

Definition 1.2.17. We say that a point p is of *multiplicity* m for C if $\frac{\partial^{i+j}}{\partial x^i \partial y^j} F(x, y)|_p = 0$ for each $0 \leq i, j; i + j \leq m - 1$.

We also mention another equivalent definition.

Definition 1.2.18. For a point $p \in \mathbb{K}^2$ and an algebraic curve C , defined by a polynomial F , we say that p is of *multiplicity m for C* if the restriction of the polynomial F onto each non-singular at p algebraic curve D has a root of multiplicity at least m at the point p , and exactly m if the curve D is generic.

A point of multiplicity m imposes $\frac{m(m+1)}{2}$ linear conditions on a_{ij} , not all of them are necessary independent. There is a full description of a matroid which encodes linear dependencies between coefficients of an equation of such a hypersurface [51, 50, 52]. That explains the relation with tropical geometry, because the non-Archimedean amoeba of a linear space keeps track of the corresponding matroid, see also Section 1.3.

Example 1.2.19. Refer to Example 1.2.10. The point $p = (1, 1)$ is a point of multiplicity $m = 3$ on the curve C' . This affects the subdivision of the Newton polygon of C' in the following way:

- The point $P = (0, 0)$ belongs to an edge E of the weight $m = 3$.
- The sum of the areas of the faces dual to the vertices of $\text{Trop}(C')$ on the extension of E is $2 + 5/2 + 1 = 11/2$, which is greater than $m^2/2 = 3^2/2$.

These two facts are particular incarnations of the Exertion Theorem for edges.

Lemma 1.2.20. Suppose $ad - bc = 1$ where $a, b, c, d \in \mathbb{Z}$. The transformation $\Psi : (x, y) \mapsto (x^a y^b, x^c y^d)$ preserves multiplicity at the point $p = (1, 1)$, i.e., $\mu_{(1,1)}(C) = \mu_{(1,1)}(\Psi(C))$.

Proof. We only need to verify that $\langle x - 1, y - 1 \rangle = \langle x^a y^b - 1, x^c y^d - 1 \rangle$ in the local ring of $(1, 1)$. If $a, b \geq 0$, then

$$x^a y^b - 1 = (x - 1 + 1)^a (y - 1 + 1)^b - 1 = (x - 1)H_1 + (y - 1)H_2;$$

if $a \geq 0, b < 0$, then we remember that we can multiply by G , such that $G(1, 1) \neq 0$, therefore

$$y^{-b}(x^a y^b - 1) = (x - 1 + 1)^a - (y - 1 + 1)^{-b} = (x - 1)H_1 + (y - 1)H_2;$$

etc. The map Ψ^{-1} is also given by an integer matrix, hence we repeat the above arguments and finally get $\langle x - 1, y - 1 \rangle = \langle x^a y^b - 1, x^c y^d - 1 \rangle$. \square

Definition 1.2.21. A map f *tropicalizes* to a map $\text{Trop}(f)$ if the following diagram is commutative:

$$\begin{array}{ccc} \mathbb{K}^2 & \xrightarrow{f} & \mathbb{K}^2 \\ \downarrow \text{Val} & & \downarrow \text{Val} \\ \mathbb{T}^2 & \xrightarrow{\text{Trop}(f)} & \mathbb{T}^2 \end{array}$$

Proposition 1.2.22. A map $\Psi : (x, y) \mapsto (x^a y^b, x^c y^d)$ tropicalizes to the integer affine map $\text{Trop}(\Psi) : (X, Y) \mapsto (aX + bY, cX + dY)$. \square

We define a new curve C' given by the equation $G(x, y) = 0$, where $G(x, y) = F(\Psi(x, y))$. Then the Newton polygon of C' is the image of Δ under $\begin{pmatrix} a & c \\ b & d \end{pmatrix} \in SL(2, \mathbb{Z})$, the same holds for the extended Newton polyhedron, and $\text{Trop}(C') = \text{Trop}(\Psi)(\text{Trop}(C))$.

Proposition 1.2.23. A map $\Psi_{r,q} : (x, y) \mapsto (rx, qy)$ with $r, q \in \mathbb{K}^*$ tropicalizes to the map $\text{Trop}(\Psi_{r,q}) : (X, Y) \mapsto (X + \text{val}(r), Y + \text{val}(q))$. \square

For $G(x, y) = \sum a'_{ij} x^i y^j$ defined as $G(x, y) = F(\Psi_{r,q}(x, y))$, an easy computation gives $\text{val}(a'_{ij}) = \text{val}(a_{ij}) + l(i, j)$ with $l(i, j) = i \cdot \text{val}(r) + j \cdot \text{val}(q)$. This adds the linear function $l(i, j)$ to the extended Newton polyhedron $\tilde{\mathcal{A}}$, therefore the subdivision of the Newton polygon for G coincides with the subdivision for F . This is not surprising because of Proposition 1.2.8 and the fact that $\text{Trop}(\Psi_{r,q})$ is a translation. Thus, $SL(2, \mathbb{Z})$ -invariant properties of the subdivision of Δ for the curve C with $\mu_p(C) = m$ for a given point $p \in (\mathbb{K}^*)^2$ do not depend on the point p .

1.2.3 Lattice width and m -thick sets

Lattice width is the most frequent notion in our arguments, already proved to be a practical tool elsewhere. For example, the article [39] uses it to estimate the gonality of a general curve with a given Newton polygon. The minimal genera of surfaces dual to a given 1-dimensional cohomology class in a three-manifold are related to the lattice width of the Alexander polynomial of this class ([62, 114]). A good survey of lattice geometry and related problems can be found in [15].

Definition 1.2.24. We denote by $P(\mathbb{Z}^2)$ the set of all directions in \mathbb{Z}^2 . Each direction u has a representative $(u_1, u_2) \in \mathbb{Z}^2$ with $\text{gcd}(u_1, u_2) = 1$. We will write $u \sim (u_1, u_2)$ in this case.

Let us consider a compact set $B \subset \mathbb{R}^2$.

Definition 1.2.25. The *lattice width* of B in a direction $u \in P(\mathbb{Z}^2)$ is $\omega_u(B) = \max_{x, y \in B} (u_1, u_2) \cdot (x - y)$, where $u \sim (u_1, u_2)$. The *minimal lattice width* $\omega(B)$ is defined to be $\min_{u \in P(\mathbb{Z}^2)} \omega_u(B)$.

Consider an interval I with rational slope and m , a positive integer number. Let $(p, q) \in \mathbb{Z}^2$ be a primitive (i.e. $\text{gcd}(p, q) = 1$) vector in the direction of I . The *lattice length* of I is its Euclidean length divided by $\sqrt{p^2 + q^2}$.

Definition 1.2.26. A set $B \subset \mathbb{R}^2$ is called *m -thick* in the following cases:

- B is empty,
- $\text{ConvHull}(B)$ is an interval with rational slope and its lattice length is at least m ,
- $\text{ConvHull}(B)$ is 2-dimensional and for each $u \in P(\mathbb{Z}^2)$, if $\omega_u(\text{ConvHull}(B)) = m - a_u$ with $a_u > 0$, then $\text{ConvHull}(B)$ has two sides of lattice length at least a_u and these sides are perpendicular to u .

The relation between m -thickness and Euler derivatives is discussed in Proposition 1.4.3 and Remark 1.4.4.

Proposition 1.2.27. If $B \subset \mathbb{Z}^2$ is m -thick and $\text{ConvHull}(B)$ is a polygon with at most one vertical side, then $\omega_{(1,0)}(B) \geq m$. If B is m -thick and $\text{ConvHull}(B)$ is a polygon without parallel sides, then $\omega(B) \geq m$. \square

Lemma 1.2.28. If $\mu_{(1,1)}(C) = m$ and $\omega_u(\mathcal{A}) = m - a$ for some $a > 0, u \sim (u_1, u_2)$, then C contains a rational component parametrized as (s^{u_1}, s^{u_2}) .

Proof. By Lemma 1.2.20, it is enough to prove this lemma only for $u = (1, 0)$. The degree of the polynomial $F(x, 1)$ is $m - a$, but $F(x, 1)$ has a root of multiplicity m at 1, therefore F is identically zero on $y = 1$, hence F is divisible by $y - 1$. Let b be the maximal number such that F is divisible by $(y - 1)^b$. Clearly $b \geq a$, otherwise we can repeat the above argument. Therefore F is divisible by $(y - 1)^a$, and this implies that both vertical sides of $\text{ConvHull}(\mathcal{A})$ have lattice length at least a . \square

Corollary 1.2.29. If $\mu_{(1,1)}(C) = m$, then the Newton polygon Δ of C is m -thick.

For a polynomial $G(x, y) = \sum b_{ij}x^i y^j$ we define its *support set* by $\text{supp}(G) = \{(i, j) | b_{ij} \neq 0\}$.

Definition 1.2.30. For $\mu \in \mathbb{R}$, denote by \mathcal{A}_μ the set $\{(i, j) \in \mathcal{A} | \text{val}(a_{ij}) \geq \mu\}$.

The sets \mathcal{A}_μ provides a stratification of \mathcal{A} which can be explained via matroid theory, see Section 1.3. The following lemma describes the set of valuations of the coefficients a_{ij} of $F(x, y)$.

Lemma 1.2.31 (*m-thickness lemma*). If $\mu_{(1,1)}(C) = m$, then for each real number μ the set \mathcal{A}_μ is m -thick (Def. 1.2.26).

Proof. We will find a polynomial G with $\text{supp}(G) = \mathcal{A}_\mu$, which defines a curve passing through $(1, 1)$ with multiplicity m . Then Corollary 1.2.29 concludes the proof. Let us consider the set of linear equations in the coefficients a_{ij} imposed by the fact that $\mu_{(1,1)}(C) = m$. If there is no required polynomial G , then by setting all the coefficients a_{ij} to 0 for $(i, j) \in \mathcal{A} \setminus \mathcal{A}_\mu$, we see that the above system of linear equations would imply that $a_{i'j'} = 0$ for some $(i', j') \in \mathcal{A}_\mu$. That would mean that there exists an equation $\sum \lambda_{ij} a_{ij} = a_{i'j'}, \lambda_{ij} \in \mathbb{Q}, (i, j) \in \mathcal{A} \setminus \mathcal{A}_\mu$ which is a consequence of the above system. The latter leads us to the contradiction, because for the polynomial F we have $\text{val}(\lambda_{ij} a_{ij}) < \mu \leq \text{val}(a_{i'j'})$ for $(i, j) \in \mathcal{A} \setminus \mathcal{A}_\mu$ (see Remark 1.2.2). The attentive reader can notice that \mathcal{A}_μ is a *flat* (see Section 1.3) in the matroid corresponding to the above linear conditions. Indeed, no dependent set intersects \mathcal{A}_μ in exactly one element, because the valuation of this element would be strictly bigger than the valuations of the other elements in this dependent set. \square

Later in Section 1.4 we relate the following definition with the Euler derivatives.

Definition 1.2.32. A finite set $B \subset \mathbb{Z}^2$ is called *algebraically m-thick* if there is no polynomial $G \in \mathbb{Z}[x, y]$ of degree $m - 1$ such that the cardinality $|B \setminus \{(x, y) | G(x, y) = 0\}|$ is 1.

Example 1.2.33. A set of two lattice points is an algebraically one-thick set. One point is not algebraically one-thick. Empty set is algebraically m -thick for any m . A collection of $m + 1$ distinct points on a line is an algebraically m -thick set.

Proposition 1.2.34. If for $B \subset \mathbb{Z}^2$ there is no $m - 1$ lines $l_1, l_2, \dots, l_{m-1} \subset \mathbb{Z}^2$ such that $|B \setminus \bigcup \{l_i\}| = 1$, then B is m -thick.

Proof. This follows from the definition of m -thick sets: take a direction u , without loss of generality we can suppose that u is horizontal. We cover B by $\omega_{(1,0)}(B)$ vertical lines such that only left or right side is not covered. Then we cover this side by horizontal lines. We can not cover all except one point, this gives an estimate on the length of vertical sides by means of $\omega_{(1,0)}(B)$ from below, this estimate turns out to be exactly the definition of m -thickness. \square

Proposition 1.2.35. For an algebraically m -thick set B there is no $m - 1$ lines $l_1, l_2, \dots, l_{m-1} \subset \mathbb{Z}^2$ such that $|B \setminus \bigcup \{l_i\}| = 1$.

Proof. Indeed, a set of $m - 1$ lines given by equations $\{p_i x + q_i y + r_i, i = 1, \dots, m - 1\}$ can be presented as the zero set of the polynomial $G = \prod (p_i x + q_i y + r_i)$ of degree $m - 1$. \square

For the future development of tropical singularity theory it would be nice to know the classification in the following questions:

Question 1. For a small m describe the minimal by inclusion (algebraically) m -thick sets of lattice width at least k at each direction.

Question 2. What is the minimal area of the convex hull of an m -thick set if its lattice width is at least k at each direction?

Question 3. Consider the triangle T_k with vertices $(0, 2k), (k, 0), (2k, k)$. Is it linearly $2k$ -thick? In fact, it is true because of Example 1.4.1, but how to prove this combinatorially? **Sage** can check the thickness of T_k for $k < 20$. One can ask another question: how many lines do we need to cover T ? Computations give $2k - 1$ if $k = 2 \pmod{3}$ and $2k$ in two other cases.

Question 4. Suppose that A is m -thick, is it true that kA is km -thick? How does the notion of m -thickness behave with respect to Minkowski sum?

Example 1.2.36. A set of $m + 1$ points on a line is algebraically m -thick. Moreover, the Newton polygon of F_k , i.e. the rectangle $\{(i, j) | 0 \leq i \leq k, 0 \leq j \leq m - k\}$ is algebraically m -thick; but it is not clear how to prove this directly from the definition.

Consider a linearly m -thick convex polygon $A \subset \mathbb{Z}^2$ of minimal lattice width m and with the area at least $m^2/2$.

Question 5. Does there exists a curve which passes through the point $(1, 1)$ with multiplicity m and has support in A ?

If we throw away the assumption about area the answer becomes *no* due to Example 1.4.2.

Remark 1.2.37. In fact, it is not simple to use the definition of *algebraic* m -thickness (see Example 1.4.10), because it operates algebraic curves. Therefore in all application we can use the following implication: if a set B is algebraically m -thick, then for any collection of lines l_1, l_2, \dots, l_{m-1} we have $|B \setminus \bigcap_{i=1..m-1} l_i| \neq 1$, see Proposition 1.2.35. Hence, by Proposition 1.2.34, the set B is m -thick. So, algebraic m -thickness, implies m -thickness, which is much more tractable.

1.3 Matroids and their Bergman fans

Here we construct the matroid associated with an m -fold point at $(1, 1)$, we also construct the corresponding Bergman fan.

Example 1.3.1. Consider the curves with $\mathcal{A} = \{(0, 0), (0, 1), (1, 0), (1, 1), (2, 1), (1, 2), (2, 2)\}$, the set \mathcal{A} is drawn on Figure 1.3 on the left. Each of these curves has an equation $F(x, y) = 0$ where

$$F(x, y) = a_{00} + a_{01}y + a_{10}x + a_{11}xy + a_{12}xy^2 + a_{21}x^2y + a_{22}x^2y^2, a_{ij} \in \mathbb{C}.$$

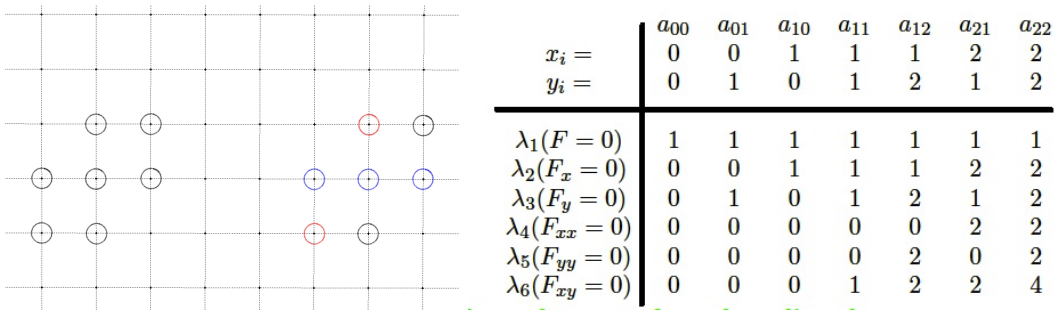

Figure 1.3: On the left picture we see the Newton polygon of the curves and three dependent sets (marked by different colors). The table of linear constraints on the coefficients a_{ij} , imposed by the point $(1, 1)$ of multiplicity 3, is on the right. The first two lines of the table are the coordinates of points in \mathcal{A} .

If a curve with such an equation has the point $(1, 1)$ as a point of multiplicity 3, then the numbers a_{ij} satisfy linear constraints written in matrix $N(\mathcal{A})$ in Figure 1.3 on the right.

The matroid $M(\mathcal{A})$, associated with $N(\mathcal{A})$, is just a structure which encodes dependencies among variables a_{ij} . A matroid consists of a ground set and collection of its subsets, which are called *dependent subsets*. In our case the ground set of $M(\mathcal{A})$ is \mathcal{A} . A set $I \subset \mathcal{A}$ is called dependent if there is a linear combination of rows of $N(\mathcal{A})$ which gives $\sum_{(i,j) \in I} c_{ij} a_{ij} = 0$.

In our example it follows from the condition λ_6 that the variables $a_{11}, a_{12}, a_{21}, a_{22}$ are dependent, i.e. there exists its linear combination which equals zero, so, the set $\{(1, 1), (1, 2), (2, 1), (2, 2)\}$ is a dependent set in $M(\mathcal{A})$.

1.3.1 Construction of the matroid of the Bergman fan

We write down the matrix $N(\mathcal{A})$ of linear conditions on a_{ij} imposed by the fact that the point $(1, 1)$ is of multiplicity m for a curve C . Columns of $N(\mathcal{A})$ are in one-to-one correspondence with a_{ij} , so, with elements of \mathcal{A} . (If the characteristic of \mathbb{K} is zero, then we can use Def. 1.2.17 of m -fold point, that with partial derivatives. Each equation $\frac{\partial^{i+j}}{\partial x^i \partial y^j} F|_{(1,1)} = 0$ induces one linear constraint on the coefficients of F . For the case of the finite characteristic it is much harder to write the general form of the constraints.)

We consider the set L of all curves C such that the support set of the equation $F(x, y) = 0$ of C belongs to \mathcal{A} and $(1, 1)$ is of multiplicity m for C . Let us identify a curve with the set of coefficients of its equation. Then, $\ker(N(\mathcal{A})) = L \subset \mathbb{K}^{|\mathcal{A}|}$ is a linear subspace. Note that the expected dimension of L is $|\mathcal{A}| - \frac{1}{2}m(m+1)$ but the actual dimension can be bigger (see Example 1.4.1).

Now we construct the matroid $M(\mathcal{A})$ encoding the dependencies between a_{ij} , see Example 1.3.1.

- Compute all generators v_i of L , build the matrix with v_i as rows and call it $m(L)$.
- Build the matroid $M(\mathcal{A})$ whose independent sets are sets of independent columns of $m(L)$. The underlying set of $M(\mathcal{A})$ is the set of columns of M , that is, the set $\{(i, j) \in \mathcal{A}\}$.

Let us recall that a *circuit* in $M(\mathcal{A})$ is a minimal by inclusion **dependent** set of columns of M .

A *flat* is a subset $S \subset \mathcal{A}$, such that $|C \setminus S| \neq 1$ for each circuit C . As in Lemma 1.2.31 we can prove that for each flat S there exists a curve in L given by $F = 0, \text{supp}(F) = S$. Now, in order to describe the flats of $M(\mathcal{A})$, we construct the Bergman fan of L (or of the matroid $M(\mathcal{A})$) which graphically represents all the possible flats.

- Take the space $\mathbb{R}^{|\mathcal{A}|}$ with basis vectors $e_{ij}, (i, j) \in \mathcal{A}$. For a flat S define a vector $e_S = \sum_{(i,j) \in S} e_{ij} \in \mathbb{R}^{|\mathcal{A}|}$.
- For all n enumerate all flags of flats $\emptyset \subset S_1 \subset S_2 \subset \dots \subset S_n = \mathcal{A}$ where all inclusions are strict.
- For each flag of flats draw the cone

$$\{w_1 e_{S_1} + w_2 e_{S_2} + \dots + w_n e_{S_n} \mid w_i \in \mathbb{R}; w_i \leq 0, \text{ if } i < n\} \quad (1.4)$$

- The union of all these cones for all n is called the *Bergman fan* of L . The top-dimensional cones correspond to the flags of maximal length.

Let us go in the opposite direction and relate the tropicalization of a linear space to the Bergman fan of the matroid $M(\mathcal{A})$. Suppose for simplicity that $\text{char } \mathbb{K} = 0$. Consider the tropicalization $T(m, \mathcal{A}) := \text{Val}(L)$, it consists of vectors $w = (w_{ij})_{(i,j) \in \mathcal{A}}$, where

$$w_{ij} = \text{val}(a_{ij}), F(x, y) = \sum a_{ij} x^i y^j; \mu_{(1,1)}(F = 0) \geq m.$$

To each vector w we will associate a *flag of flats* $\emptyset \subsetneq S_1 \subsetneq S_2 \subsetneq \dots \subsetneq S_n \subsetneq \mathcal{A}$, where

$$w_{ij} < w_{ls} \iff \exists q : (i, j) \in S_q, (l, s) \notin S_q.$$

In fact, this is just the stratification provided by \mathcal{A}_μ (Def. 1.2.30).

Let us construct the sets S_q by the following procedure. Note that once fixed $w_{ij} = \text{val}(a_{ij})$ we can compute \mathcal{A}_μ (Def. 1.2.30) for each real μ . Let $\{S_l\}$ be the set of sets $\mathcal{A} \setminus \mathcal{A}_\mu$ where μ runs over all real numbers.

The valuations w_{ij} can be reconstructed by the following rule

$$w_{ij} = \sum_{(i,j) \in S_l} w_l,$$

where w_l are from (1.4).

So, an element of L gives us a flag of flats. In the opposite direction, a flag of flats gives a subset of L . The Bergman fan of L is exactly the set $T(m, \mathcal{A})$ ([10, 51]).

Theorem 1.3.2 ([52]). Each flag of flats $\emptyset \subsetneq S_1 \subsetneq S_2 \subsetneq \dots \subsetneq \mathcal{A}$ associated with a vector in the fan $T(m, \mathcal{A})$ possesses the following property: for each $l \in \mathbb{N}$ the set $\mathcal{A} \setminus S_l$ is algebraically m -thick.

1.4 Examples and the Euler derivative

Example 1.4.1. Fix $k \in \mathbb{N}$. The polygon T_k of the minimal area with $\omega(T_k) = 2k$ is the triangle with vertices $(0, 0)$, $(k, 2k)$, $(2k, k)$ (see Remark 1.8.16). The triangle T_k comes as the support set of the polynomial $(1 - 3xy + xy^2 + x^2y)^k = 0$ which defines a curve C with $\mu_{(1,1)}(C) = 2k$. The area of T_k is $\frac{3}{8}(2k)^2$, which shows that the estimate in the Exertion Theorem for vertices is sharp.

If $\text{char } \mathbb{K} = 0$, then $\mu_{(1,1)}(C) \geq 2k$ is equivalent to the set of linear equations $\frac{\partial^{q+r}}{\partial x^q \partial y^r} F(x, y) = 0$, $q + r < 2k$ in the coefficients of the polynomial $F = \sum_{(i,j) \in T_k} a_{ij} x^i y^j$. Note that among these equations, there are at least

$$\frac{2k(2k+1) - (3k^2 + 3k + 2)}{2} = \frac{k^2 - k - 2}{2}$$

linearly dependent ones. Here $\frac{2k(2k+1)}{2}$ is the number of equations and $\frac{3k^2+3k+2}{2}$ is the number of variables, i.e., the number of integer points in T .

Example 1.4.2. To see one more phenomenon we consider the set

$$\mathcal{A} = \text{ConvHull}((0, 0), (1, 3), (6, 3), (6, 4), (3, 6), (3, 1)) = T_3 \cup \{(1, 3), (3, 1), (6, 4)\}.$$

The only curve C with support in \mathcal{A} and $\mu_{(1,1)}(C) = 6$ is given by the equation $(1 - 3xy + xy^2 + x^2y)^3 = 0$. Hence adding three new monomials $a_{13}xy^3 + a_{31}x^3y + a_{64}x^6y^4$ does not add new degrees of freedom and a_{13}, a_{31}, a_{64} are always 0.

We give the following explanation. Consider the constraint on a_{ij} imposed by the fact that $F_{xx}(1, 1) = 0$. That is $\sum i(i-1)a_{ij} = 0$. Note that the set of a_{ij} with non-zero coefficients in this equation is parametrized by $\mathcal{A} \setminus \{(i, j) | i(i-1) = 0\}$. So, we say that $i(i-1)$ corresponds to F_{xx} .

In a similar way, given $\mu_{(1,1)} = 6$, by considering linear combinations of $F, F_x, F_{xy}, \dots, F_{yyyyy}$, we can obtain all the polynomials in i, j of degree at most five. Next, $(6, 4)$ is the only point in \mathcal{A} where $f(i, j) = (j-3)(i-j)(i-3)(i^2+j^2-ij-3j-3i+6)$ is not zero. The linear equation corresponding to $f(i, j)$,

$$(F_{xxxxy} - 2F_{xxxxy} + 2F_{xxyyy} - F_{xyyyy} - 3F_{xxxx} + 4F_{xxxxy} - 4F_{xyyy} + 3F_{yyyy} - 12F_{xx} + 12F_{yy} + 24F_x - 24F_y)|_{(1,1)} = 0,$$

written in terms of a_{ij} , is just $a_{64} = 0$. Similar combinations of derivatives can be found for a_{13} and a_{31} .

To proceed the general case we fix a polynomial $f = \sum p_{ij}x^i y^j$ of degree $m - 1$. Consider associated differential operator $\hat{f} = \sum p_{ij}\partial_x^i \partial_y^j$. Since the point $(1, 1)$ is of multiplicity m for C we have $\hat{f}(F)|_{(1,1)} = 0$. We consider the derivative $\partial_x^k \partial_y^l (F)|_{(1,1)} = \sum_{(i,j) \in \mathcal{A}} i(i-1)\dots(i-k+1)j(j-1)\dots(j-l+1)a_{ij} = \sum_{(i,j) \in \mathcal{A}} f_{kl}(i, j)a_{ij}$. Each polynomial in $\mathbb{Q}[i, j]$ of degree no more than $m - 1$ can be obtained as a linear combination of the polynomials $f_{kl}(i, j)$ with $k, l \leq m - 1$.

Note that $\hat{f}(F)|_{(1,1)} = \sum p_{kl}f_{kl}(i, j)a_{ij} = 0$, therefore the set $(i, j) \in \mathcal{A} | \sum p_{kl}f_{kl}(i, j) \neq 0$ can not contain exactly one element. Since any polynomial of degree at most $m - 1$ can be expressed as $\sum p_{kl}f_{kl}(i, j)$, we have finished the proof.

For the sake of simplicity we only discuss here the dimension two case in characteristic zero but the results of this section are easily reformulated and can be proven in any dimension and even for any valuation field with characteristic zero or bigger than m .

So, let $\text{char } \mathbb{K} = 0$. In this case, [50] contains the complete description of the matroid M associated with the linear conditions imposed by the m -fold point at $(1, 1)$. Namely, all the dependent sets of M , minimal by inclusion, are the sets of the type $\mathcal{A} \setminus \{(i, j) | G(i, j) = 0\}$, where $G \in \mathbb{K}[i, j]$ is a polynomial of degree at most $m - 1$.

Let \mathcal{A}_G be $\mathcal{A} \setminus \{(t, w) | G(t, w) = 0\}$. We call the operation

$$\partial_G : \sum_{(i,j) \in \mathcal{A}} a_{ij}x^i y^j \rightarrow \sum_{(i,j) \in \mathcal{A}_G} a_{ij}x^i y^j$$

the *Euler derivative with respect to G* . Suppose that a tropical curve H is given by $\text{Trop}(F)$ where F is as in (1.1).

Proposition 1.4.3 ([50]). A point $P \in H$ is a point of multiplicity at least m in the \mathbb{K} -extrinsic sense (Def. 1.1.2) if and only if for each polynomial $G \in \mathbb{K}[i, j]$ of degree no more than $m - 1$, the tropical curve given by $\text{Trop}(\partial_G F)$ passes through P .

Remark 1.4.4. If $\text{char } \mathbb{K} = 0$, then the above proposition implies the m -thickness property for \mathcal{A} if $\mu_{(1,1)}(C) = m$ (cf. Corollary 1.2.29). Indeed, if the set \mathcal{A} is not m -thick, then there exists a collection of $m - 1$ lines l_1, \dots, l_{m-1} such that $\mathcal{A} \setminus \bigcup \{l_i\} = (i', j') \in \mathbb{Z}^2$. Let the polynomial G be the product of the equations of the lines l_i . Clearly, $\deg(G) = m - 1$. Then, $\partial_G F = a_{i'j'}x^{i'}y^{j'}$, and $\text{Trop}(\partial_G F)$ is smooth at P . This contradicts to Proposition 1.4.3.

We give here another proof of Corollary 1.2.29. Consider a curve C defined by (1.1), let C pass through $(1, 1)$ with multiplicity m .

Definition 1.4.5. The *support set* $\text{supp}(F)$ of a polynomial $F(x, y) = \sum a_{ij}x^i y^j$ is, by definition, the set $\text{supp}(F) = \{(i, j) \in \mathbb{Z}^2 | a_{ij} \neq 0\}$.

The next lemma claims, roughly speaking, that differentiation of F acts on $\text{supp}(F)$ as throwing away a line. The simplest example of this phenomenon is $\text{supp}(x\partial_x(F)) = \text{supp}(F) \setminus \{(i, j) | i = 0\}$.

Lemma 1.4.6. The set $\text{supp}(F)$ is m -thick.

Proof. Let us proceed by induction. The case $m = 1$ is obvious: $\text{supp}(F)$ should have at least two elements. Consider $m > 1$. Choose any line l which covers at least one point of $\text{supp}(F)$, without loss of generality l has a rational slope. Consider a toric transformation $\Psi : (x, y) \rightarrow (x^a y^b, x^c y^d)$ such that the integer affine transformation $\text{Trop}(\Psi)$ brings l to the line given by the equation $x = n, n \in \mathbb{Z}$. It follows from Lemma 1.2.20 that the curve $\Psi(C)$ passes through $(1, 1)$ with multiplicity m . Let the equation of $\Psi(C)$ be $G(x, y) = 0$, it is clear that the $\text{supp}(G) = \text{Trop}(\Psi)(\text{supp}(F))$.

Compute the derivative $\frac{\partial(x^{-n}G)}{\partial x}$ of the polynomial G at the point $(1, 1)$:

$$\frac{\partial(x^{-n}G)}{\partial x} \Big|_{(1,1)} = (G \cdot \frac{\partial x^{-n}}{\partial x} + x^{-n} \partial G) \Big|_{(1,1)} = x^{-n} \partial G(x, y) \Big|_{(1,1)} = 0$$

Therefore the curve defined by the equation $F' = x^n \cdot \frac{\partial(x^{-n}G)}{\partial x} = 0$ passes through $(1, 1)$ with multiplicity $m - 1$, the support set $\text{supp}(F')$ is equal to the set $\text{Trop}(\Psi)(\text{supp}(F) \setminus l)$, by induction $\text{supp}(F')$ is $(m - 1)$ -thick and we proceed as in Remark 1.4.4. \square

So, one can say that throwing a line from $\text{supp}(F)$ can be obtained by a differentiation twisted by a toric change of coordinates.

Let us consider numbers $a, b, c, d \in \mathbb{Z}$, such that $ad - bc = 1$.

Remark 1.4.7. Define a derivation in a direction (a, c) on a monomial $x^i y^j$ by $\partial_{(a,c)} x^i y^j = (ai + cj)x^{i-d} y^{j+b}$ and extend it by linearity on $\mathbb{C}[x, y]$. The usual derivatives ∂_x and ∂_y are $\partial_{(1,0)}$ and $\partial_{(0,1)}$ respectively (we consider the tuples $(a, b, c, d) = (1, 0, 0, 1)$ in the case ∂_x and $(0, -1, 1, 0)$ in the case ∂_y). The above lemma implies that a point $(1, 1)$ is of multiplicity m for the curve $F(x, y) = 0$ if and only if for any pair (r, q) of integer numbers and any derivation $\partial_{(a,c)}$ the equation $\partial_{(a,c)}(x^r y^q F(x, y))$ defines a curve which passes through $(1, 1)$ with multiplicity $m - 1$. That leads exactly to the notion of m -thickness in spirit of Propositions 1.2.34, 1.2.35 and Remark 1.4.4, because

$$\text{supp}(x^{d-r} y^{-b-q} \partial_{(a,c)}(x^r y^q F(x, y))) = \text{supp}(F) \setminus \{(i, j) | a(i+r) + c(j+q) = 0\}$$

Example 1.4.8. Of course, an equation, which we get by a coordinate change and a derivation, is not a new information, it follows from the constraints in Def. 1.2.17. For example, on the level of equations on a_{ij} the constraint given by $\frac{\partial}{\partial x}(x^{-n} F(x, y)) \Big|_{(1,1)} = 0$ is the same as the equation $(F_x(x, y) - nF(x, y)) \Big|_{(1,1)} = 0$, the latter follows from $F(1, 1) = 0$ and $F_x(1, 1) = 0$.

Remark 1.4.9. Note that $\partial_{(p,q)}$ is **not** a composition of the derivatives $\partial_{(1,0)}$ and $\partial_{(0,1)}$. In the notation of Lemma 1.4.6 we have $\partial_{(a,c)} = \Psi^{-1} \circ \frac{\partial}{\partial x} \circ \Psi$.

In the papers [106, 107] the space of planar tropical singular curves and the space of tropical singular surfaces in \mathbb{TP}^3 are described. The authors straightforwardly describe properties of maximal dimension cones in $T(2, \mathcal{A})$, that is, roughly speaking, the possible variants of $\mathcal{A} \setminus F_n$ and $\mathcal{A} \setminus F_{n-1}$ for flags of maximal length. Lemma 1.4.6 explains the idea of what they do. Thanks to Example

1.4.8, the derivatives $\partial_{a,b}$ defined above (and the concept of m -thickness) is another way to study matrix $N(\mathcal{A})$.

One can be tempted by a question: is it true that all circuits of $M(L)$ can be constructed as sets $\mathcal{A} \setminus \bigcup_{i=1}^{m-1} \{l_i\}$ for some collection of $m - 1$ lines? Example 1.3 answers negatively.

Example 1.4.10. Blue and red points represents two line on Figure 1.3, left part. It follows from the m -thickness Theorem, that the rest, i.e., the set $\{(1, 0), (2, 2)\}$, should be a dependent set in $M(\mathcal{A})$. Indeed, $2\lambda_2 + \lambda_5 - 2\lambda_6 = 0 = 2a_{10} - 2a_{22}$. Blue points as well as red also represent dependent sets.

Let us check whether \mathcal{A} is linearly 3-thick or not: first of all, try to remove from \mathcal{A} two lines, which represent a reducible curve of degree 2. The set $\mathcal{A}' = \mathcal{A} \setminus \{(1, 1)\}$ has no set of three points on a line, therefore if we throw away from \mathcal{A} any two lines, then at least two points remain. Hence, \mathcal{A} is 3-thick.

On the other hand, the set $\{(1, 1)\}$ is a dependent set, because $\lambda_6 - \lambda_5 - \lambda_4 = 0 = a_{11}$, but there is no two lines l_1, l_2 such that $\{(1, 1)\} = \mathcal{A} \setminus (l_1 \cup l_2)$. This suggests that the set \mathcal{A} is not algebraically 3-thick (Def. 1.2.32), because the fact that $(1, 1)$ is of multiplicity 3 for C implies that $a_{11} = 0$, but we prohibited to have zero coefficients in \mathcal{A} . We also can check that \mathcal{A} is not algebraically 3-thick by definition: indeed, $\mathcal{A} \setminus \{ij - i(i - 1) - j(j - 1) = 0\} = \{(1, 1)\}$.

On the other hand, the set $\mathcal{A}' = \mathcal{A} \setminus \{(1, 1)\}$ is algebraically 3-thick. As we established above, there is no two lines l_1, l_2 such that $|\mathcal{A}' \setminus \{l_1 \cap l_2\}| = 1$. Also \mathcal{A}' lies on the quadric $ij - i(i - 1) - j(j - 1) = 0$ which intersects any other quadric by 4 points at maximum, therefore $|\mathcal{A}' \setminus \{Q = 0\}| \geq 6 - 4 = 2$, where Q is any quadric curve.

One can argue that in Examples 1.4.1, 1.4.2 we have a smaller degree of freedom because the curves were reducible, so, let us look at the following example.

Example 1.4.11. Consider the curve C' given by the equation

$$(x^2y + xy^2 - 3xy + 1)^8 + xy^4(x - 1)^8 = 0. \quad (1.5)$$

The curve C' is irreducible, $\mu_{(1,1)}(C') = 8$. The number of integer points in the Newton polygon of C' is 35, which is less than the number of linear conditions on the coefficients (imposed by the point of multiplicity 8), namely 36.

1.5 A lemma about concave functions

Suppose that $h : [a, b] \rightarrow \mathbb{R}$ is a concave and piecewise smooth function on the interval $[a, b]$. Define $\hat{h}_{[a,b]}(x)$ as the length of the subinterval of $[a, b]$ where the values of h are at least $h(x)$, i.e., $\hat{h}_{[a,b]}(x) = \text{measure}\{y \in [a, b] | h(y) \geq h(x)\}$.

Lemma 1.5.1. Suppose that h attains its maximal value at a unique point. Then $\int_a^b \hat{h}_{[a,b]}(x) dx = (b - a)^2 / 2$.

Proof. Without loss of generality $h(a) \geq h(b) = 0$. Let q be the point where the maximum of h is attained. On the intervals $[a, q]$ and $[q, b]$ the function h is invertible. Call the respective inverses

f_1, f_2 , that is $f_1(h(x)) = x$ for $x \in [a, q]$ and $f_2(h(x)) = x$ for $x \in [q, b]$. For $y \in [0, h(a)]$, we define $f_1(y) = a$. Hence $f_1(h(q)) = f_2(h(q)) = q, f_1(0) = a, f_2(0) = b$. Let $H(y) = f_2(y) - f_1(y)$; note that $H(y) = \hat{h}(f_1(y)) = \hat{h}(f_2(y))$. Finally, we integrate $\hat{h}_{[a,b]}(x)$ along the y -axis. In between, we change the measure in the integration. The integral becomes

$$\int_a^b \hat{h}_{[a,b]}(x)dx = \int_{h(q)}^0 (h_2(y) - h_1(y))d(h_2(y) - h_1(y)) = \int_{h(q)}^0 H(y)d(H(y)) = \frac{H^2(0)}{2} = \frac{(b-a)^2}{2}. \quad \square$$

Corollary 1.5.2. If $h(a') = h(b')$ for some $a' < b'$ in $[a, b]$, then

$$\int_a^{a'} \hat{h}_{[a,b]}(x)dx + \int_{b'}^b \hat{h}_{[a,b]}(x)dx = \frac{1}{2}((b-a)^2 - (b'-a')^2).$$

Proof. We proceed as in the proof of the lemma, and

$$\int_a^{a'} \hat{h}_{[a,b]}(x)dx + \int_{b'}^b \hat{h}_{[a,b]}(x)dx = \int_{h(a')}^0 H(y)d(H(y)) = \frac{1}{2}((b-a)^2 - (b'-a')^2). \quad \square$$

Proposition 1.5.3. If h is linear with non-zero slope on an interval $[a', b'] \subset [a, b]$, then the function \hat{h} is concave on $[a', b']$.

Proof. Without loss of generality we suppose that $a' < b', f(a') < f(b')$. It is enough to check that $\hat{h}(\frac{1}{2}(x+y)) \geq \frac{1}{2}(\hat{h}(x) + \hat{h}(y))$ for $x, y \in [a', b']$. Since $h(\frac{1}{2}(x+y)) = \frac{1}{2}(h(x) + h(y))$, we have

$$\begin{aligned} \hat{h}\left(\frac{1}{2}(x+y)\right) &= f_2\left(h\left(\frac{1}{2}(x+y)\right)\right) - f_1\left(h\left(\frac{1}{2}(x+y)\right)\right) = f_2\left(h\left(\frac{1}{2}(x+y)\right)\right) - \frac{1}{2}\left(f_1(h(x)) + f_1(h(y))\right) \\ &\geq \frac{1}{2}\left(f_2(h(x)) + f_2(h(y))\right) - \frac{1}{2}\left(f_1(h(x)) + f_1(h(y))\right) = \frac{1}{2}\left(\hat{h}(x) + \hat{h}(y)\right), \end{aligned}$$

because $f_2 \circ h$ is concave on the interval $[x, y]$. Note that linearity of h and f_1 on $[x, y]$ is crucial, since f_1 has a negative coefficient. \square

There are generalizations of this lemma for the functions $\mathbb{R}^n \rightarrow \mathbb{R}$.

Lemma 1.5.4. Let B be a compact set in \mathbb{R}^n , $f : B \rightarrow \mathbb{R}$ a continuous function. Let $\hat{f} : \mathbb{R} \rightarrow \mathbb{R}$ is defined by $\hat{f}(x) = \text{measure}(y \in B | f(y) \geq x)$. Then $\int_{\min_B f}^{\max_B f} g(\hat{f})(x)dx = G(\text{Volume}(B)) - G(0)$ where G is a primitive function of g .

Proof. The same as for the previous lemma. \square

Question 6. In the same spirit, we can define another function for the order on the points in \mathbb{R}^2 . Let $(x, y) < (x', y')$ iff $x < x'$ and $y < y'$. Now, for a function $f : B \rightarrow \mathbb{R}^2$ we define $\hat{f}(a, b) = \text{measure}(x \in B | f(x) \geq f(a, b))$. What is the integral of \hat{f} ?

1.6 Formulation of main theorems

In this section, we state the main results of this chapter. For the terminology of faces, vertices, edges, and the duality among them, refer to Proposition 1.2.8.

1.6.1 Influenced sets

We consider a tropical curve $H \subset \mathbb{T}^2$ and a point $Q \in H$.

Definition 1.6.1. Let $l_Q(u)$ be the line through Q in the direction $u \in P(\mathbb{Z}^2)$. Take the connected component, containing Q , of the intersection $H \cap l_Q(u)$. We call this component *the long edge through Q in the direction u* and denote it by $E_Q(u)$.

Definition 1.6.2. For each $u \in P(\mathbb{Z}^2)$ we denote by $\mathfrak{J}_Q(u)$ the set of vertices of H which belong to the long edge $E_Q(u)$. Define $\mathfrak{J}(Q) = \bigcup_{u \in P(\mathbb{Z}^2)} \mathfrak{J}_Q(u)$.

The union of all the long edges at Q , i.e. $\bigcup_{u \in P(\mathbb{Z}^2)} E_Q(u)$ is so-called *star* at the point Q . So, $\mathfrak{J}(Q)$ is just the set of vertices of H lying in the star of Q , cf. Definition 1.7.5 and Definition 2.2.5.

Note that $\mathfrak{J}(Q)$ is not a multiset; it contains only one copy of Q . Examples of $\mathfrak{J}(P)$ are presented in Figure 1.1. On the left we see one long edge $E_P((1,0))$ and $\mathfrak{J}(P)$ consists of 7 vertices, and above we see 7 corresponding faces in the subdivision of Δ . On the right, we see long edges $E_P((1,0)), E_P((0,1)), E_P((-1,1))$. Each of the long edges $E_P((1,2))$ and $E_P((-3,-2))$ consists of only one edge. In Example 1.2.10, $E_P((1,0))$ is the union of the horizontal edges of $\text{Trop}(C')$ and $\mathfrak{J}(P)$ is the set of all vertices of $\text{Trop}(C')$.

Definition 1.6.3. For a point $Q \in H$ we define $\mathfrak{J}\text{nf}\ell(Q) = \bigcup_{V \in \mathfrak{J}(Q)} d(V)$, the union of the faces of the Newton polygon of H , dual to the vertices in $\mathfrak{J}(Q)$.

Definition 1.6.4. For a point $Q \in H$ which is not a vertex of H , we define

$$\text{area}(\mathfrak{J}\text{nf}\ell(Q)) = \sum_{F \in \mathfrak{J}\text{nf}\ell(Q)} \text{area}(F).$$

Note that $\text{area}(\mathfrak{J}\text{nf}\ell(Q))$ depends only on H and does not depend on a particular choice of an equation defining H . Also, if Q belongs to an edge E of H and Q is not a vertex of H , then $\mathfrak{J}_u(Q) = \mathfrak{J}(Q)$ where u is the direction of E . Indeed, for any other direction v not collinear to u , the connected component of Q in the intersection $H \cap l_Q(v)$ is just Q .

Recall that if Q is a vertex of H , then $d(Q)$ is a face dual to Q in the subdivision of Δ .

Definition 1.6.5. If Q is a vertex of H , we define

$$\begin{aligned} \text{area}(\mathfrak{J}\text{nf}\ell(Q)) &= \sum_{F \in \mathfrak{J}\text{nf}\ell(Q)} \text{area}(F) + \text{area}(d(Q)), \\ \text{area}^*(\mathfrak{J}\text{nf}\ell(Q)) &= \sum_{F \in \mathfrak{J}\text{nf}\ell(Q)} \text{area}(F). \end{aligned}$$

From the point of view of combinatorics, studying $\text{area}^*(\mathfrak{J}\text{nf}\ell(Q))$ is more natural, whereas $\text{area}(\mathfrak{J}\text{nf}\ell(Q))$ is motivated by Nagata's conjecture (see Chapter 2 for details). The name $\mathfrak{J}\text{nf}\ell(P)$ is chosen because the linear constraints, imposed by the fact $\mu_p(C) = m$, asymptotically *influence* (cf. Remark 1.1.1) the coefficients a_{ij} where $(i, j) \in \mathfrak{J}\text{nf}\ell(P)$, $P = \text{Val}(p)$.

1.6.2 Multiplicity of a tropical point in the intermediate sense

Consider a tropical curve H given by a tropical polynomial $\text{Trop}(F)$. Using $\text{Trop}(F)$, we construct the extended Newton polyhedron $\tilde{\mathcal{A}}$ for H .

Definition 1.6.6. We denote by $\tilde{\mathcal{A}}_\mu$ the xy -projection of the intersection of $\tilde{\mathcal{A}}$ with the plane $z = \mu$.

Note that \mathcal{A}_μ (Def. 1.2.30) is contained in $\tilde{\mathcal{A}}_\mu$. In Figure 1.6 (below), the set $\tilde{\mathcal{A}}_\mu$ is colored in gray.

Definition 1.6.7. A point $P = (0, 0)$ on the tropical curve H is of multiplicity at least m in the intermediate sense (we write $\mu_P^{\text{trop}}(H) \geq m$) if for each $\mu \in \mathbb{R}$ the set $\tilde{\mathcal{A}}_\mu$ is m -thick (Def. 1.2.26).

Using Proposition 1.2.23, we can use this definition for any other point of $P \in \text{Val}((\mathbb{K}^*)^2)$, after an appropriate change of coordinates.

Lemma 1.6.8. If $\mu_p(C) = m$ and $P = \text{Val}(p)$, then $\mu_P^{\text{trop}}(\text{Trop}(C)) \geq m$.

Corollary 1.6.9. If a point P on a tropical curve $H \subset \mathbb{T}^2$ is of multiplicity at least m in the \mathbb{K} -extrinsic sense (Def. 1.1.2), then P is of multiplicity at least m for H in the intermediate sense.

Unfortunately, this lemma does not immediately follow from Lemma 1.2.31.

1.6.3 Exertion Theorems

If $\omega(\mathcal{A}) < m$, i.e., $\omega_u(\mathcal{A}) < m$ for some $u \sim (u_1, u_2)$ (Def. 1.2.24), and $\mu_p(C) = m, p = (p_1, p_2)$, then Lemma 1.2.28 asserts that C contains a rational component with parameterization $(p_1 s^{u_1}, p_2 s^{u_2})$. We are going to prohibit such cases.

Definition 1.6.10. A tropical curve is *admissible* if the minimal lattice width (Def. 1.2.25) of its Newton polygon is at least m .

The following theorems estimate the total area of the region of influence of P in Δ . The point P exerts its influence on the faces whose area is counted in the theorem, whence the name.

Theorem 1.6.11 (Exertion Theorem for edges). If H is admissible, $\mu_P^{\text{trop}}(H) = m$ (Def. 1.6.7), and P is not a vertex of H , then $\text{area}(\mathfrak{Infl}(P)) \geq \frac{1}{2}m^2$ (Def. 1.6.4). Furthermore, if $E \subset H$ is the edge of H , containing P , then the lattice length of $d(E)$ is at least m .

In this case we see a collection of faces with parallel sides in the subdivision of Δ ; see Figure 1.1(A).

Theorem 1.6.12 (Exertion Theorem for vertices). If H is admissible, $\mu_P^{\text{trop}}(H) = m$, and the point P is a vertex of H , then $\text{area}^*(\mathfrak{Infl}(P)) \geq \frac{3}{8}m^2$ and $\text{area}(\mathfrak{Infl}(P)) \geq \frac{1}{2}m^2$ (Def. 1.6.5).

Here we will see a collection of faces like in Figure 1.1(B). The Exertion theorems are valid only for admissible curves. The following example illustrates this problem.

Example 1.6.13. Consider a curve C' defined by the polynomial $F_k(x, y) = (x - 1)^k(y - 1)^{m-k}$. Clearly, $\mu_{(1,1)}(C') = m$, but the curve $\text{Trop}(C')$ is not admissible. The Newton polygon of F_k is the rectangle with vertices $(0, 0), (k, 0), (0, m - k), (k, m - k)$, it is m -thick and its area is $k(m - k)$ which is always less than $\frac{3}{8}m^2$. The curve C' consists of the line $x = 1$ with multiplicity k and the line $y = 1$ with multiplicity $m - k$. The tropical curve $\text{Trop}(C')$ consists of the vertical line of weight k and the horizontal line of weight $m - k$. Note that Lemma 1.6.8 holds in this example.

1.7 Intrinsic definition of a tropical m -fold point

The *multiplicity* $m(P)$ of the point P of the intersection of two lines in directions $u, v \in P(\mathbb{Z}^2)$ is $|u_1v_2 - u_2v_1|$ where $u \sim (u_1, u_2), v \sim (v_1, v_2)$ (Def. 1.2.24).

Given two tropical curves $A, B \subset \mathbb{T}^2$ we define their *stable intersection* as follows. Let us choose a generic vector v . Then we consider the curves $T_{tv}A$ where $t \in \mathbb{R}, t \rightarrow 0$ and T_{tv} is the translation by the vector tv . For a generic small positive t , the intersection $T_{tv}A \cap B$ is transversal and consists of points $P_i^t, i = 1, \dots, k$ with multiplicities $m(P_i^t)$ which do not depend on t as far as t is small enough.

Definition 1.7.1 (cf. [142]). For each connected component X of $A \cap B$, we define *the local stable intersection of A and B along X* as $A \cdot_X B = \sum_i m(P_i^t)$ for t close to zero, where the sum runs over $\{i \mid \lim_{t \rightarrow 0} P_i^t \in X\}$. For a point $Q \in A$, we define $A \cdot_Q B$ as $A \cdot_X B$, where X is the connected component of Q in the intersection $A \cap B$.

Definition 1.7.2. A generalized tropical line is the non-smooth locus of a function (1.3) with $\mathcal{A} \subset \mathbb{Z}^2$ such that \mathcal{A} is an interval of lattice length 1 or $|\mathcal{A}| = 3, \text{area}(\text{ConvHull}(\mathcal{A})) = \frac{1}{2}$.

Proposition 1.7.3. Let Q be a vertex of a tropical curve H . If the face $d(Q)$ has no vertical sides, and L is the usual horizontal line through Q , then $H \cdot_Q L = \omega_{(1,0)}(d(Q))$.

Proof. This follows from a direct computation and Proposition 1.2.8. □

Definition 1.7.4. A point P on a tropical curve H is of multiplicity at least m *in the intrinsic sense* if for each generalized tropical line L through P we have $L \cdot_P H \geq m$.

Definition 1.7.5. Given $Q \in H$, we call *the star* $\text{Star}(Q)$ *at Q* the connected component of Q in the intersection $H \cap \bigcup_{u \in P(\mathbb{Z}^2)} \{l_Q(u)\}$ (Def. 1.6.1). Note that only the vertices of H in $\text{Star}(Q)$ contribute to the multiplicity of Q in the intrinsic sense. Also, this set of vertices coincides with $\mathfrak{J}(Q)$ (Def. 1.6.2).

Proposition 1.7.6. Let P be of multiplicity m in the intrinsic sense. If P is a vertex of H , then $d(P)$ is m -thick (Def. 1.2.26). If P is not a vertex of H , then the edge of H containing P is of weight at least m .

Proof. For each $u \in P(\mathbb{Z}^2)$, we can find a generalized tropical line L such that P is the vertex of L , and L has an edge in the direction u . Like in Proposition 1.7.3, a direct calculation of $L \cdot_P H$ finishes the proof. □

Now consider Example 1.2. The edge with P has weight 3, therefore the stable intersection with each non-horizontal line is at least 3. The stable intersection of H with the horizontal line through P is exactly the width of the Newton polygon of the curve in the direction $(1, 0)$.

Consider an edge of H through P . Without loss of generality we can suppose that this edge is horizontal. Let A_1 (resp. A_2) be the leftmost (resp. rightmost) vertex of H on the horizontal long edge $E_P((1, 0))$ (Def. 1.6.1).

Proposition 1.7.7 (cf. Lemma 1.9.16 and Section 3.4.4). If P is of multiplicity m in the intrinsic sense and $E_P((1, 0)) = A_1A_2$, then the difference between x -coordinates of the leftmost vertex of $d(A_1)$ and rightmost vertex of $d(A_2)$ is at least m .

Proof. Let L be the usual line containing E . A direct calculation of $L \cdot_P H$ concludes the proof. \square

Proposition 1.7.8. Suppose that $P \in H$ is not a vertex of H . Let P belongs to an edge E of H with endpoints A_1 and A_2 . Let P be of multiplicity m for H in the intrinsic sense. Suppose that $E_P((1, 0)) = E$. Then $\text{area}(d(A_1)) + \text{area}(d(A_2)) \geq \frac{1}{2}m^2$.

Proof. The lattice length of $d(E)$ is at least m and the sum of the heights of $d(A_1)$ and $d(A_2)$ is at least m by Proposition 1.7.7. Therefore

$$\text{area}(d(A_1)) + \text{area}(d(A_2)) \geq m \cdot m/2. \quad \square$$

1.8 Two combinatorial lemmata

*Les sages qui veulent parler au vulgaire leur langage au lieu du sien
n'en sauraient être entendus.*

Jean-Jacques Rousseau

Definition 1.8.1. The *defect* of $B \subset \mathbb{Z}^2$ in a direction $u \in P(\mathbb{Z}^2)$ is $\text{def}_u(B) = \max(m - \omega_u(B), 0)$.

This section is devoted to the proofs of the following statements.

Lemma 1.8.2. For an m -thick (Def. 1.2.26) lattice polygon B we have

$$\text{area}(\text{ConvHull}(B)) + \frac{1}{2} \sum_{u \in P(\mathbb{Z}^2)} \text{def}_u(B)^2 \geq \frac{3}{8}m^2.$$

Lemma 1.8.3. For an m -thick lattice polygon B we have

$$2 \cdot \text{area}(\text{ConvHull}(B)) + \frac{1}{2} \sum_{u \in P(\mathbb{Z}^2)} \text{def}_u(B)^2 \geq \frac{1}{2}m^2.$$

Unfortunately, though the proofs use only standard combinatorial arguments, they are cumbersome and rather tedious. Thus the reader is recommended to skip this section while reading this paper the first time.

1.8.1 Using the direction $(0, 1)$ or the direction $(1, 1)$

Suppose that B is not $(m + 1)$ -thick and the minimal lattice width $a \leq m$ of B is attained in the horizontal direction. Using the m -thickness property, we can find two points M, L on the left vertical side of B and two points N, K on the right vertical side in such a way (Figure 1.4(A)) that the distances ML and NK are equal to $m - a$, so $MNKL$ is a parallelogram. Let us call it the *initial* parallelogram. Note that in the case $a = m$ we have a degenerate initial parallelogram with $M = L, N = K$.

Definition 1.8.4. Denote by $x(A)$ (resp. $y(A)$) the x -coordinate (resp. y -coordinate) of a point $A \in \mathbb{Z}^2$.

Let $b = y(M) - y(N)$. Applying a suitable coordinate change in $SL(2, \mathbb{Z})$ we may assume that $0 \leq b < a$; see Figure 1.4(A).

Proposition 1.8.5. The width $\omega_{(0,1)}(MNKL)$ of the initial parallelogram $MNKL$ in the direction $(0, 1)$ is equal to $m - a + b$. The width $\omega_{(1,1)}(MNKL)$ is equal to $m - b$. \square

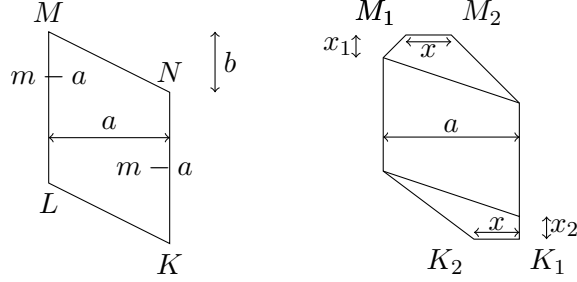

Figure 1.4: The initial parallelogram $MNKL$ is depicted on the left. The set B is m -thick. Therefore, by taking into consideration $\omega_{(0,1)}(B)$, we find a polygon $MM_1M_2NKK_1K_2L$, which is a subset of B .

Suppose that $\omega_{(0,1)}(B) = m - x$. Thus, by Proposition 1.8.5, $x \leq a - b$, and B must have two horizontal sides M_1M_2, K_1K_2 , whose lengths are at least x . Note that it is possible that $x = 0$; in that case we can choose $M_1 = M_2 \in B, K_1 = K_2 \in B, y(M_1) - y(K_1) = m$. So, B contains a polygon $MM_1M_2NKK_1K_2L$. A particular example of such a polygon is shown in Figure 1.4, right side. Let $x_1 = x(M_1) - x(M), x_2 = x(K) - x(K_1)$. The inequality $x_1 + x_2 \geq m - (m - a + b + x)$ holds because B is m -thick. All the notation is presented in Figure 1.4 and this picture serves as the main illustration tool for the following computations.

Note that

$$\text{area}(MM_1M_2NKK_1K_2L \setminus MNKL) \geq a(x_1 + x_2)/2 + x(b + x_1 + b + x_2)/2, \quad (1.6)$$

and the minimum is attained if the bottom horizontal edge is in the extremal right position (like at the bottom in Figure 1.4(B)), and the top edge is in the extremal left position. Look at the top of Figure 1.4(B): we minimize the area of $MM_1M_2NKK_1K_2L$, preserving $MNKL$ and x_1, x_2 . For that, we should move the interval M_1M_2 to the left as much as possible, while preserving the convexity of $MM_1M_2NKK_1K_2L$.

Definition 1.8.6. Define $S_{(0,1)} = \frac{1}{2} \text{def}_{(0,1)}(B)^2 + 2 \cdot \text{area}(B \setminus (MNKL))$.

Using (1.6), we see that

$$S_{(0,1)} \geq x^2/2 + a(x_1 + x_2) + x(b + x_1 + b + x_2) \geq a(a - b) + xb - x^2/2. \quad (1.7)$$

Remark 1.8.7. If $c_2 < 0$, then a function $f(x) = c_2x^2 + c_1x + c_0$ defined on an interval $[c_3, c_4]$ always attains its minimum at c_3 or c_4 .

We will extensively use this fact below. In particular, $x \in [0, a - b]$ and (1.7) implies that

$$S_{(0,1)} \geq \min(a(a - b), a(a - b) + (a - b)(b - \frac{a - b}{2})).$$

Moreover, if $b \geq a/3$, then $S_{(0,1)} \geq a(a - b)$. If $b \leq a/3$, then

$$S_{(0,1)} \geq a(a - b) + (3b - a)(a - b)/2.$$

Lemma 1.8.8. If $b \leq a/3$, then $S_{(0,1)} \geq a^2/2$.

Proof. In this case $S_{(0,1)} \geq a(a - b) + (3b - a)(a - b)/2$. It follows from Remark 1.8.7 that it is enough to consider the cases $b = 0$ and $b = a/3$. \square

We repeat the above procedure for the direction $(1, 1)$. We define $y = m - \omega_{(1,1)}(B)$. Then, let N_1N_2, L_1L_2 be the vertices of two sides of B , perpendicular to the direction $(1, 1)$. Let y_1, y_2 be the increments of $\omega_{(1,1)}$ obtained by adding N_1, N_2, L_1, L_2 to $MNKL$. Then, $y_1 + y_2 \geq b - y$ because B is m -thick. On Figure 1.5 we have $y_1 = 0, y_2 = 1$; note that $y_2 = 2$ because $\omega_{(1,1)}(\{(0, 0), (1, 1)\}) = 2$.

Definition 1.8.9. We denote $S_{(1,1)} = \frac{1}{2}\text{def}_{(1,1)}(B)^2 + 2 \cdot \text{area}(B \setminus (MNKL))$.

By direct calculation of the areas of the triangles $L_1L_2K, LL_1K, MN_1N_2, MN_2N$, we obtain

$$S_{(1,1)} \geq y^2/2 + a(y_1 + y_2) + y(a - b + y_1 + a - b + y_2) \geq -y^2/2 + ab + y(a - b). \quad (1.8)$$

Proposition 1.8.10. The following inequalities hold: 1) if $b \leq 2a/3$, then $S_{(1,1)} \geq ab$,
2) if $b \geq 2a/3$, then $S_{(1,1)} \geq ab + b(2a - 3b)/2$.

Proof. It follows from (1.8), Remark 1.8.7, and the fact that $0 \leq y \leq b$. \square

This proposition implies the following lemma.

Lemma 1.8.11. If $b \geq 2a/3$, then $S_{(1,1)} \geq a^2/2$.

Proof. Again, if $b = a$, then we obtain $S_{(1,1)} \geq a^2/2$; for $b = 2a/3$, we get $S_{(1,1)} \geq 2a^2/3$. \square

Lemma 1.8.12. The following inequality holds:

$$2 \cdot \text{area}(B \setminus (MNKL)) + \frac{1}{2} \sum_{\substack{u \in P(\mathbb{Z}^2), \\ u \neq (1,0)}} \text{def}_u(B)^2 \geq \frac{a^2}{2}.$$

Proof. Indeed, if $a/3 \leq b \leq 2a/3$, then $S_{(0,1)} + S_{(1,1)} \geq a^2$ and we are done. Two other cases are covered by Lemmata 1.8.8, 1.8.11. \square

Proof of Lemma 1.8.3. It follows from the previous lemma that

$$\begin{aligned} 2 \cdot \text{area}(\text{ConvHull}(B)) + \frac{1}{2} \sum_{u \in P(\mathbb{Z}^2)} \text{def}_u(B)^2 &\geq 2 \cdot \text{area}(MNKL) + \frac{1}{2}a^2 + \frac{1}{2}\text{def}_{(1,0)}(B)^2 \\ &\geq 2(a(m - a)) + \frac{1}{2}a^2 + \frac{1}{2}(m - a)^2 \geq \frac{1}{2}m^2 + a(m - a), \end{aligned}$$

and $a(m - a) \geq 0$. \square

1.8.2 Using both directions $(0, 1)$ and $(1, 1)$

Now we will use the widths of B in the directions $(0, 1), (1, 1), (1, 0)$ at the same time. Consider the directions $(0, 1), (1, 1)$, and define x, y, x_1, y_1, x_2, y_2 as in the previous subsection. Now, B contains the polygon $s(B) = MM_1M_2NN_1N_2KK_1K_2LL_1L_2$. Some of its vertices are allowed to coincide. Refer to Figure 1.5. We assume that the polygon $s(B)$ satisfies the condition of m -thickness in the directions $(0, 1), (1, 0), (1, 1)$. Our goal is to find an estimate for the area of $s(B)$ in terms of m, a, x, y . We can suppose that $s(B)$, with the above requirements, is the minimal polygon by area.

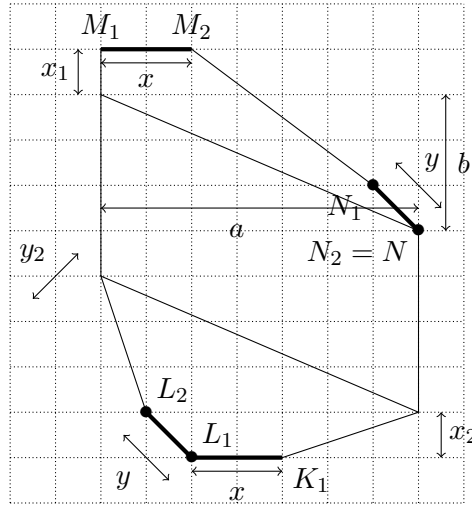

Figure 1.5: In this example $m = 11, a = 7$, and $y_1 = 0$ (therefore $N = N_2$). The vertices $MNKL$ are as in Figure 1.4(A), the vertices M_1M_2, K_1, K_2 are as in Figure 1.4(B), and L_1 and K_2 coincide. We are looking for the minimum of the sum of the area of this polygon and $\frac{1}{2}(x^2 + y^2)$.

Lemma 1.8.13. The pairs of intervals M_1M_2, N_1N_2 and K_1K_2, L_1L_2 either share a common vertex (like K_1K_2 and L_1L_2 in the bottom of Figure 1.5), or are maximally far from each other (like M_1M_2 and N_1N_2 at the top of the picture).

Proof. This lemma follows from the fact that the area changes linearly when we move the sides $K_1K_2, L_1L_2, M_1, M_2, N_1, N_2$, preserving the distances x, y, x_1, y_1, x_2, y_2 . \square

Let A_1 denote the minimal area of the top augmented piece ($MM_1M_2N_1N_2N$) when N_1N_2 and M_1M_2 are maximally far from each other (Figure 1.5, top). Let A_2 denote the minimal area of the bottom augmented piece ($LKK_1K_2L_1L_2$) when L_1L_2 and K_1K_2 are maximally far from each other. Let A_3 denote the minimal area of the top augmented piece when $N_1 = M_2$. Let A_4 denote the minimal area of the bottom augmented piece when $L_1 = K_2$ (Figure 1.5, bottom).

Lemma 1.8.14. For A_1, A_2, A_3, A_4 defined above, we have $A_1 - A_3 = A_2 - A_4$.

Proof. Computing $\omega_{0,1}(B), \omega_{1,1}(B)$, we get relations $x_1 + x_2 = a - b - x, y_1 + y_2 = b - y$. Now, by direct computations we obtain

$$A_1 = \frac{1}{2}(ax_1 - yx_1 - yb + yy_1 + ay_1 + ay + xx_1 + xb - xy_1 - xy).$$

Replacing x_1 with x_2 and y_1 with y_2 and using the above relations we obtain the formula for A_2 :

$$A_2 = \frac{1}{2}(a^2 - ax_1 + yx_1 + by - yy_1 - y^2 - ay_1 - ay - xx_1 - x^2 - xb + xy_1 + xy).$$

For A_3, A_4 we get

$$A_3 = \frac{1}{2}(yy_1 + xx_1 + ax_1 + ab - b^2 - bx_1 + by_1),$$

$$A_4 = \frac{1}{2}(-yy_1 - y^2 - xx_1 - x^2 + a^2 - ab - ax_1 + bx_1 - by_1 + b^2).$$

It is straightforward to see that $A_1 - A_3 = A_4 - A_2$. \square

If $A_1 < A_3$, then $A_4 < A_2$. Therefore, the minimal total sum of the areas of the augmented pieces is $A_1 + A_4$ or $A_2 + A_3$. Suppose that the minimum is attained in the case $A_1 + A_4$.

Lemma 1.8.15. $\text{area}(s(B) \setminus MNKL) + \frac{1}{2}(\text{def}_{(0,1)}(B)^2 + \text{def}_{(1,1)}(B)^2) \geq \frac{3}{8}a^2$.

Proof. The area of $s(B) \setminus MNKL$ is at least $A_1 + A_4$, $\text{def}_{(0,1)}(B) = x, \text{def}_{(1,1)}(B) = y$, and

$$A_1 + A_4 + \frac{1}{2}x^2 + \frac{1}{2}y^2 = \frac{1}{2}(a^2 - ab + b^2 + xb + y(a - b - x) + x_1(b - y) + y_1(a - b - x)).$$

Minimizing, we get $x_1 = y_1 = 0$. Next, $y = 0, x = 0$. Finally, minimizing $\frac{1}{2}(a^2 - ab + b^2)$ with respect to b , we obtain $\frac{3}{8}a^2$. \square

Proof of Lemma 1.8.2. Using the previous Lemma, we get

$$\text{area}(\text{ConvHull}(B)) + \frac{1}{2} \sum_{u \in P(\mathbb{Z}^2)} \text{def}_u(B)^2 \geq \frac{1}{2}(m - a)^2 + a(m - a) + \frac{3}{8}a^2 \geq \frac{3}{8}m^2,$$

and equality is attained if $a = m$. \square

Corollary 1.8.16. As a side effect, for the special case $a = m$, Lemma 1.8.2 gives

Theorem 1.8.17 ([59], based on [18], p. 716, formula II_3 , p. 715 formula I). Let $B \subset \mathbb{Z}^2$ be a finite set. Then $\text{area}(\text{ConvHull}(B)) \geq \frac{3}{8}\omega(B)^2$.

In fact, from the above proofs it is easy to extract the extremal cases and exact bounds: if $\omega(B) = 2k$, then $\text{area}(\text{ConvHull}(B)) \geq \frac{3}{2}k^2$, and if $\omega(B) = 2k + 1$, then $\text{area}(\text{ConvHull}(B)) \geq \frac{1}{2}(3k^2 + 3k + 1)$.

Remark 1.8.18. The best constant c_n in the inequality $\text{Volume}(\text{ConvHull}(B)) \geq c_n \omega(B)^n$ for $B \subset \mathbb{Z}^n$ is not known for $n > 2$. The above theorem says that $c_2 = \frac{3}{8}$. We survey this question with more details in Chapter A.

1.9 The proofs of the Exertion Theorems

Firstly, we introduce the notation which we use throughout the remainder of this chapter. Then we prove Lemma 1.6.8 and the Exertion Theorems.

1.9.1 Notation

This section has a lot in common with Section 3.4.4, where we treat singular points with tropical modification theory, except that the methods explained below are more powerful in the case of two dimensions.

Let H be a tropical curve, given by (1.3). The extended Newton polyhedron of H is $\tilde{\mathcal{A}}$. We suppose that the point $P \in H$ is not a vertex of H . We assume that $P = (0, 0)$ and the edge E containing P is horizontal. We consider the long edge $\mathfrak{E} = E_P((1, 0))$.

Call the vertices on \mathfrak{E} from left to right $A_1, A_2, A_3, \dots, A_n$. Clearly, we have $\mathfrak{I}_P((1, 0)) = \bigcup_{i=1}^n \{A_i\}$ (Def. 1.6.2). We denote by E_i the edge of H such that $E_i \subset \mathfrak{E}$ and the left end of E_i , if it exists, is the point A_i . If \mathfrak{E} contains an infinite edge of H without a left end, as in Example 1.2.10, we call it E_0 . Let P belong to E_ℓ . Refer to Figure 1.6 for this notation.

If A_1 is the left end of \mathfrak{E} , then for the consistency of notation we add a “fictive” edge E_0 which has length zero; $d(E_0)$ will denote the leftmost vertex of the face $d(A_1)$. We say that $d(E_0)$ is a vertical edge of zero length. Similarly, if A_n is the right end of \mathfrak{E} , then we add a “fictive” edge E_n which has length zero; $d(E_n)$ will denote the rightmost vertex of the face $d(A_n)$. Now, regardless of finiteness of \mathfrak{E} , we always have edges E_0, E_1, \dots, E_n . Since \mathfrak{E} is horizontal, it follows from Proposition 1.2.8 that for each $i = 0, \dots, n$ the edge $d(E_i)$ is vertical.

Definition 1.9.1. Refer to Figure 1.7(A). Let x_i be the x -coordinate of the edge $d(E_i)$. By $y_i \leq y^i$ we denote the y -coordinates of the endpoints of $d(E_i)$, and by $m_i = y^i - y_i$ the lattice length of $d(E_i)$.

Note that we have $y_i = y^i$ if and only if $i = 0$ (resp. $i = n$) and the long edge \mathfrak{E} is finite on the left (resp. right) side.

Proposition 1.9.2. For each $i = 1, \dots, n$, we have

$$\text{area}(d(A_i)) \geq \frac{1}{2}(x_i - x_{i-1})(m_i + m_{i-1}). \quad (1.9)$$

Proof. Since $d(A_i)$ has two vertical sides of lengths m_i, m_{i-1} , the inequality follows from the convexity of $d(A_i)$. \square

Definition 1.9.3. Recall that for each edge E' of H , there is the dual edge $d(E')$ in the subdivision of Δ . Also, all the edges in the subdivision of Δ arise as the projections of the edges of $\tilde{\mathcal{A}}$. We denote by $L(d(E'))$ the lifting of an edge $d(E')$ in the boundary of $\tilde{\mathcal{A}}$.

If $d(E_0)$ is a point, then we denote by $L(d(E_0))$ the corresponding vertex of $\tilde{\mathcal{A}}$. We apply the same rule for $d(E_n)$: look at the point $d(E_4)$ in Figure 1.6.

Proposition 1.9.4. For each $i = 1, \dots, n$, the face of $\tilde{\mathcal{A}}$ spanned by $L(d(E_{i-1}))$ and $L(d(E_i))$ projects to the face $d(A_i)$.

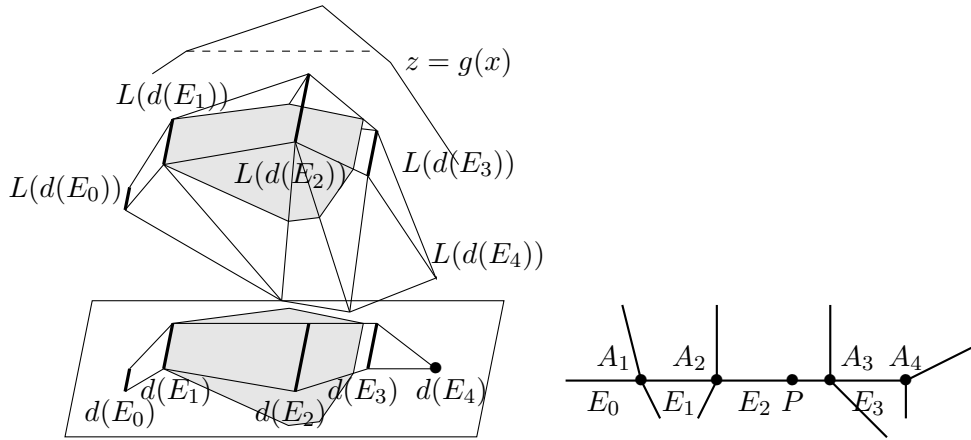

Figure 1.6: On the left we see a part of the extended Newton polyhedron, which corresponds to a horizontal long edge on the right. The long edge $E_P((1, 0))$ consists of the edges E_0, E_1, E_2, E_3, E_4 , $l = 2$, and $\mathfrak{J}(P) = \{A_1, A_2, A_3, A_4\}$. The edges $L(d(E_i))$ of $\tilde{\mathcal{A}}$ are depicted as thick black horizontal intervals, while a section of the extended Newton polyhedron by a horizontal plane is marked in gray, as well as its projection onto the xy -plane. The projection of $\tilde{\mathcal{A}}$ onto the xz -plane is also depicted; the projection of the section is dashed. Note that we added a fictive edge E_4 , and $d(E_4)$ is the rightmost vertex of $d(A_4)$.

Proof. This follows from Proposition 1.2.8. Refer to Figure 1.6. \square

The edge E_ℓ is horizontal and passes through $(0, 0)$. That implies the following lemma. Nevertheless, we give more details to illustrate the notation.

Lemma 1.9.5. The direction of the edge $L(d(E_\ell))$ is $(0, 1, 0)$ and $L(d(E_\ell))$ is higher than all other points of $\tilde{\mathcal{A}}$.

Proof. Refer to Figure 1.2. The top end $(x_l, y^l) \in \mathcal{A}$ of $d(E_l)$ represents the tropical monomial $M_1 = \text{val}(a_{x_l y^l}) + x_l X + y^l Y$ of $\text{Trop}(F)$; M_1 dominates other monomials in the region above the edge E_l . The bottom end $(x_l, y_l) \in \mathcal{A}$ of $d(E_l)$ represents the monomial $M_2 = \text{val}(a_{x_l y_l}) + x_l X + y_l Y$ which dominates other monomials in the region below the edge E_l . Therefore M_1 and M_2 are equal on the edge E_l , in particular at the point $(0, 0)$; therefore $\text{val}(a_{x_l y^l}) = \text{val}(a_{x_l y_l})$, hence $L(d(E))$ is horizontal. Furthermore, $\max_{(i,j) \in \mathcal{A}} (\text{val}(a_{ij}) + iX + jY) = \text{val}(a_{x_l y^l}) = \text{val}(a_{x_l y_l})$ at the point $(0, 0)$.

If for some i, j we have $\text{val}(a_{ij}) = \text{val}(a_{x_l y^l})$, then $i = x_l$, otherwise $P = (0, 0)$ is a vertex of H . It follows from the maximality of $\text{val}(a_{x_l y^l}) + x_l X + y^l Y$ in the region above E_l that $j \leq y^l$; then $y_l \leq j$ by symmetric reasoning. \square

Refer to Figure 1.6: the height of each bold edge $d(E_k)$ on the left side of the picture is greater than the heights $\text{val}(a_{ij})$ of the points $(i, j, \text{val}(a_{ij}))$ such that (i, j) lies to the left of E_k . In other words, the projections of the bolded edges on the xz -plane lie on the boundary of the xz -projection of $\tilde{\mathcal{A}}$.

Lemma 1.9.6. Consider an edge E_q with $q < l$. For each $(i, j) \in \mathcal{A}$ with the property 1) $i < x_q$ or 2) $i = x_q, j < y_q$, or 3) $i = x_q, j > y^q$, the number $\text{val}(a_{ij})$ is less than $\text{val}(a_{x_q y_q}) = \text{val}(a_{x_q y^q})$. The symmetric statement holds for $q > l$.

Proof. Refer to Figure 1.6. Each two consecutive edges $d(E_i), d(E_{i+1})$ bound the face $d(A_{i+1})$, therefore the edges $L(d(E_i)), L(d(E_{i+1}))$ (bolded in Figure 1.6) also bound a face of the polyhedron $\tilde{\mathcal{A}}$. The edges $d(E_i)$ are all parallel to $d(E_l)$, therefore all the edges $L(d(E_i))$ are parallel to each other as well. Provided $\tilde{\mathcal{A}}$ is a convex polytope, all the points $(i, j, \text{val}(a_{ij}))$ lie under each plane passing through a face of $\tilde{\mathcal{A}}$. The part with $q > l$ can be proven by a word-by-word repetition of the above arguments. \square

Definition 1.9.7. Define $v_q := \text{val}(a_{x_q y_q}) = \text{val}(a_{x_q y^q})$, the height of the edge $L(d(E_q))$.

Lemma 1.9.6 implies that $v_0 < v_1 < \dots < v_\ell > v_{\ell+1} > \dots > v_n$.

Let us project the boundary of $\tilde{\mathcal{A}}$ to the xz -plane. Each edge $L(d(E_i))$ is projected to the point (x_i, v_i) (Figure 1.6(A) and Figure 1.7(B) show examples of the result of such a projection).

Definition 1.9.8. Let $g(x)$ equal $\max\{z \mid (x, y, z) \in \tilde{\mathcal{A}}\}$.

The xz -projection of the face of $\tilde{\mathcal{A}}$ stretched on the edges $L(d(E_i)), L(d(E_{i+1}))$ coincides with the graph of g on the interval $[x_i, x_{i+1}]$, i.e., with the interval $(x_i, v_i), (x_{i+1}, v_{i+1})$ (compare Figures 1.6 and 1.7).

For $x' \in [x_0, x_n]$ let $\hat{g}(x')$ be the length of the interval excised from the line $z = g(x')$ by the graph of g (see Figure 1.7, and the definition before Lemma 1.5.1).

Remark 1.9.9. If P is a vertex of H , then we can repeat all the above steps for each long edge through P .

1.9.2 The proof of Lemma 1.6.8

In Example 1.2.10, G can be written as

$$t^{-3} \cdot x(y-1)^3 + t^{-2} \cdot x(x-1)(y-1)^2 + t^{-1} \cdot (x-1)^2(y-1) + t^2 \cdot (x-1)^3.$$

Therefore, in that example the extended Newton polyhedron is made of layers of m -thick sets, namely $\text{supp}(x(y-1)^3), \text{supp}(x(x-1)(y-1)^2), \text{supp}((x-1)^2(y-1)), \text{supp}((x-1)^3)$.

Let $H = \text{Trop}(C)$ and $\mu_{(1,1)}(C) \geq m$. We will prove that the horizontal sections of $\tilde{\mathcal{A}}$ passing through the edges $L(d(E_i)), i = 0, \dots, n$ are m -thick. Then we extend this result to all the horizontal sections by Proposition 1.5.3.

Proposition 1.9.10. If P is not a vertex of H , then the edge $d(E_l)$ (see Section 1.9.1 for the notation) has the lattice length at least m .

Proof. Let $\mu' = \max\{\mu \in \mathbb{R} \mid \mathcal{A}_\mu \neq \emptyset\}$. Clearly, $d(E_l) = \text{ConvHull}(\mathcal{A}_{\mu'})$. By the m -thickness Lemma, $d(E_l)$ is m -thick, which finishes the proof. \square

Remark 1.9.11. If P is a vertex of $\text{Trop}(C)$, then the same reasoning shows that $\tilde{\mathcal{A}}_{\mu'} = d(P)$ is m -thick. Furthermore, $\tilde{\mathcal{A}}_\mu$ (Def. 1.6.6) always contains $\mathcal{A}_{\mu'}$ for each $\mu < \mu'$.

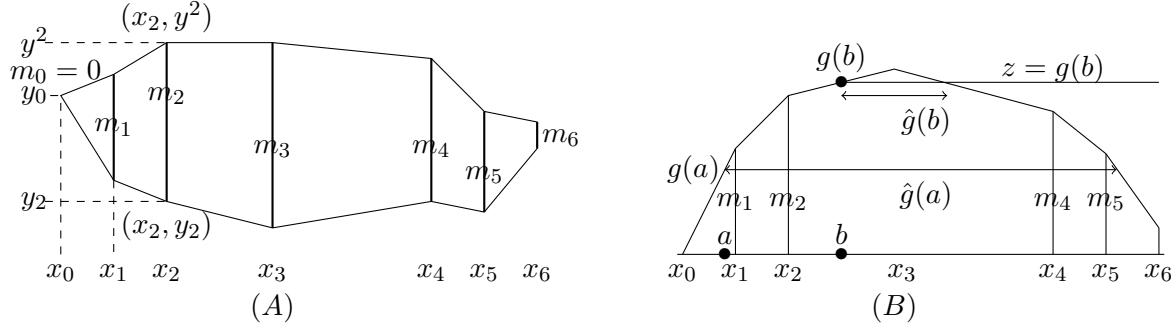

Figure 1.7: Projections of $\tilde{\mathcal{A}}$ to the xy -plane (A) and to the xz -plane (B) are depicted. The number x_i is the x -coordinate of the edge $d(E_i)$ in (A). In this example, the long edge $E_P((1, 0))$ is finite from the left side (therefore $m_0 = 0$) and infinite from the right side (therefore $m_n = m_6 > 0$). By definition $g(x_i) = v_i$ in (B). Also, $\hat{g}(a)$ and $\hat{g}(b)$ are presented in (B), and $\hat{g}(x_3) = 0, l = 3$. The key observation is that $\hat{g}(x_i) + m_i \geq m$ (Lemma 1.9.12). Furthermore, \hat{g} is concave on $[x_i, x_{i+1}]$ for each i ; see Proposition 1.5.3 for details.

By the m -thickness Lemma, for each $i = 0, \dots, n$, the set \mathcal{A}_{v_i} is m -thick. The following Lemma estimates the length of $d(E_i)$ via the width $\hat{g}(x_i)$ of the horizontal section through $L(d(E_i))$.

Lemma 1.9.12. For each $i = 0, 1, \dots, n$, the length m_i of the edge $d(E_i)$ is at least $m - \hat{g}(x_i)$.

Proof. We draw the horizontal section $\{z = v_i\}$ through the bold edge $L(d(E_i))$; refer to Figure 1.6 where $i = l - 1$. Consider the line $z = g(x_i)$ in the xz -plane. Suppose that the projection of the interval, excised on this line by the graph of g , onto the x -axis is $[x_i, x'_i], x'_i > x_i$. In fact, the length $\hat{g}(x_i)$ of the dashed line in Figure 1.6 satisfies $\hat{g}(x_i) = x'_i - x_i = \omega_{(1,0)}(\tilde{\mathcal{A}} \cap \{z = v_i\}) = \omega_{(1,0)}(\tilde{\mathcal{A}}_{v_i})$. The set \mathcal{A}_{v_i} is inside the strip $\{(x, y) \mid x_i \leq x \leq x'_i\}$, and \mathcal{A}_{v_i} is m -thick by the m -thickness Lemma. Since $\text{ConvHull}(\mathcal{A}_{v_i}) \cap \{x = x_i\}$ is $d(E_i)$, this lemma follows from the definition of m -thickness. \square

Remark 1.9.13. In fact, \mathcal{A}_{v_i} is contained in the xy -projection of $\{z = v_i\} \cap \tilde{\mathcal{A}}$, but does not necessarily coincide with it.

Consider the following piecewise linear function f on the interval $[x_0, x_n]$: let $f(x_i) = m_i$ for $i = 0, \dots, n$, then extend f to be linear on each interval $[x_i, x_{i+1}]$.

Proposition 1.9.14. The length of the left vertical side of $\text{ConvHull}(\tilde{\mathcal{A}}_{g(x)}, x \leq x_l)$ is at least $f(x)$.

Proof. It follows from the fact that the face of $\tilde{\mathcal{A}}$ stretched on $L(d(E_i)), L(d(E_{i+1}))$ contains the trapezoid stretched on $L(d(E_i)), L(d(E_{i+1}))$, and f calculates the lengths of its intersection with horizontal sections. \square

Lemma 1.9.15. The inequality $f(x) + \hat{g}(x) \geq m$ holds on the interval $[x_0, x_n]$.

Proof. For each $i = 0, \dots, n$ the inequality $f(x_i) + \hat{g}(x_i) \geq m$ is satisfied by Lemma 1.9.12. Consider an interval $[x_i, x_{i+1}]$. Since f is linear and \hat{g} is concave on $[x_i, x_{i+1}]$ (Proposition 1.5.3), we have $f(x) + \hat{g}(x) \geq m$ for each $x \in [x_i, x_{i+1}]$. \square

Proof of Lemma 1.6.8. Suppose that P is not a vertex of $\text{Trop}(C)$ and P belongs to a horizontal edge of $\text{Trop}(C)$. It follows from Remark 1.9.11 that it is enough to check the m -thickness of $\tilde{\mathcal{A}}_\mu$ only in the direction $(1, 0)$. The latter follows from Lemma 1.9.15 and Proposition 1.9.14. If P is a vertex of $\text{Trop}(C)$, then, again, Remark 1.9.11 implies that we need to check the m -thickness of $\tilde{\mathcal{A}}_\mu$ only in the directions of the edges through P . For each edge through P , we use Propositions 1.2.22, 1.2.23 for making this edge horizontal. Then we repeat the above arguments. \square

1.9.3 Proof of the Exertion theorem for edges

The second part of the Exertion Theorem for edges is proved in Proposition 1.9.10.

Lemma 1.9.16 (cf. Lemma 1.7.7). Refer to Figure 1.7(A) for the notation. If H is admissible (Def. 1.6.10) and $\mu_P^{\text{trop}}(H) \geq m$, then $x_n - x_0 \geq m$.

Proof. Let us suppose that $x_n - x_0 < m$. If $m_0, m_n > 0$, then $\omega_{(1,0)}(\mathcal{A}) = x_n - x_0 < m$, and the curve H is not admissible. If $m_0 = 0$ and $m_n > 0$, then $\omega_{(1,0)}(\mathcal{A}_{v_0}) < m$ and \mathcal{A}_{v_0} does not have two vertical sides, which contradicts the fact that \mathcal{A}_{v_0} is m -thick (Proposition 1.2.27). If both $m_0 = m_n = 0$, then we apply the above argument for $\mathcal{A}_{\max(v_0, v_n)}$. \square

Proposition 1.9.17. If a point P is of multiplicity at least m in the intermediate sense, then P is of multiplicity at least m in the intrinsic sense (Def. 1.7.4).

Proof. Indeed, let us take a generalized tropical line L . We will verify Def. 1.7.4. If P is the vertex of L or $\text{Star}(P)$ does not contain the vertex of L , then the fact that $\tilde{\mathcal{A}}_\mu$ is m -thick (Remark 1.9.11) implies that $L \cdot_P H \geq m$. If the vertex V of L belongs to a long edge through P , then we use the notation in Section 1.9.1. We may assume that L has a horizontal edge passing through P . Let V belongs to E_k . Draw the horizontal section through $L(d(E_k))$. A direct calculation and Lemma 1.9.12 show that m -thickness of $\tilde{\mathcal{A}}_{v_k}$ implies that $L \cdot_P H \geq m$. \square

It follows from Lemma 1.9.16 that

Proposition 1.9.18. There are points $b, c \in [x_0, x_n]$ such that $c - b = m$ and one of the following statements hold

- $g(b) = g(c)$,
- $g(b) \leq g(c), c = x_n$,
- $g(b) \geq g(c), b = x_0$.

The points b, c are chosen in such a way that $\hat{g}_{[b,c]}(x) = (\hat{g}_{[x_0, x_n]})|_{[b,c]}(x)$ for $x \in [b, c]$. By $h|_{[b,c]}$ we mean the restriction of h to $[b, c]$. The definition of $f(x)$ is given before Lemma 1.9.15.

Proof of Theorem 1.6.11. We complete the proof, applying Lemma 1.5.1 on the interval $[b, c]$ of length m :

$$\text{area}(\mathfrak{J}\text{nf}(P)) \geq \int_{x_0}^{x_n} f(x)dx \geq \int_b^c f(x)dx \geq \int_b^c (m - \hat{g}(x))dx \geq m(c - b) - \frac{(c-b)^2}{2} = \frac{m^2}{2}. \quad \square$$

Proposition 1.9.19 (cf. Lemma 3.3.19). If $E_P((1, 0))$ coincides with the interval $[A_1, A_n]$ and $x_n - x_0 = m$, then only one point $P \in [A_1, A_n]$ can be a point of multiplicity m in the intermediate sense.

Proof. Indeed, using the m -thickness property of $\mathcal{A}_{\max(v_0, v_n)}$, we conclude that $v_0 = v_n$ (cf. Lemma 1.9.16). This is equivalent to the fact that $\text{val}(a_{x_0 y_0}) = \text{val}(a_{x_n y_n})$, where (x_0, y_0) is the leftmost vertex of $d(A_1)$ and (x_n, y_n) is the rightmost vertex of $d(A_n)$; see Figure 1.7. All this notation (Section 1.9.1) was developed for the case $P = (0, 0)$. Then, using Proposition 1.2.23, we see that the choice of another point $P' \in [A_1, A_n]$ and a subsequent change of the coordinates in order to make $P' = (0, 0)$ will destroy the equality $v_0 = v_n$. \square

We can prove in Example 1.2.10, that if P is of multiplicity 3 in the extrinsic sense, then P must divide the edge in the ratio 1 : 2. Also, in the hypothesis of the above proposition, it is possible to determine the position of the singular point via tropical modifications, see Section 3.4.4.

1.9.4 Proof of the Exertion theorem for vertices

Now we are in the hypothesis of the Exertion Theorem for vertices, i.e. $\mu_P^{\text{trop}}(H) \geq m$, P is a vertex of H , and the Newton polygon Δ of H has minimal lattice width at least m . For each direction $u \in P(\mathbb{Z}^2)$ such that the face $d(P)$ has at most one side perpendicular to u , the width $\omega_u(d(P))$ is at least m . This follows from Lemma 1.2.28, since $d(P)$ is m -thick.

Suppose that the point P belongs to an edge $E \subset H$ of direction u . If $\omega_u(d(P)) < m$, then the face $d(P)$ has two sides of lattice length at least $\text{def}_u(d(P))$ (Def. 1.8.1), and these sides are perpendicular to the vector u ; see Figure 1.8.

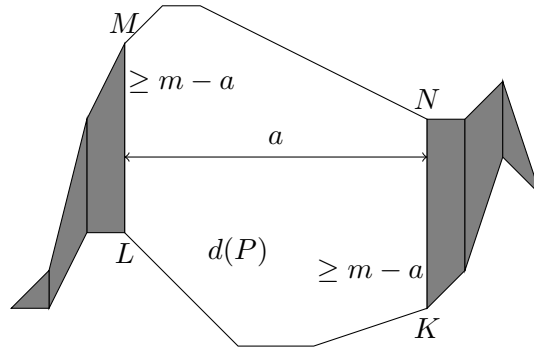

Figure 1.8: An example of the dual picture to a horizontal long edge through P , if P is a vertex of H . We have $\omega_{(1,0)}(d(P)) = a$ and $\mu_P^{\text{trop}}(H) \geq m$, therefore the lengths of LM and NK are at least $m - a$. The set $\bigcup d(Q)$ for $Q \in \mathfrak{J}_{(1,0)}(P), Q \neq P$ is colored. Lemma 1.9.20 states that the sum of the areas of the colored faces is at least $\frac{1}{2}(m - a)^2$.

Lemma 1.9.20. If $\mu_P^{\text{trop}}(H) \geq m$, P is a vertex of H , and $u \in P(\mathbb{Z}^2)$, then

$$\sum_{V \in \mathcal{J}_P(u), V \neq P} \text{area}(d(V)) \geq \frac{1}{2} \text{def}_u(d(P))^2. \quad (1.10)$$

Proof. Applying a change of coordinates (Proposition 1.2.22), we may assume that $u = (1, 0)$. Let $\omega_u(d(P)) = a$. The faces of the subdivision contributing to (1.10) are colored in Figure 1.8. Now we consider the set $\{(i, j) \in \mathbb{Z}^2\}$ where $\text{val}(a_{ij})$ is maximal. It contains the vertices of $d(P)$ and maybe some integer points inside $d(P)$. As in the proof of the Exertion Theorem for edges, we consider the sets A_μ for different μ , and repeat all the other steps. In the final step of the proof, instead of the integral $\int_b^c (m - \hat{g}) dx$ we consider the integral $\int_b^{x_i} (m - \hat{g}) + \int_{x_{i+1}}^c (m - \hat{g})$ where x_i, x_{i+1} are the x -coordinates of the vertical sides of $d(P)$. Finally,

$$\begin{aligned} \sum_{Q \in \mathcal{J}_u(P), Q \neq P} \text{area}(d(Q)) &\geq \int_b^{x_i} (m - \hat{g}) dx + \int_{x_{i+1}}^c (m - \hat{g}) dx \\ &= m(x_i - b) + m(c - x_{i+1}) - \int_b^{x_i} \hat{g} dx - \int_{x_{i+1}}^c \hat{g} dx \\ &= m(m - a) - \left(\frac{1}{2}(c - b)^2 - \frac{1}{2}(x_{i+1} - x_i)^2 \right) = \frac{1}{2}(m - a)^2 = \frac{1}{2} \text{def}_u(d(P))^2, \end{aligned}$$

by Corollary 1.5.2. □

Proof of Theorem 1.6.12. Indeed, it follows from Lemma 1.9.20 that

$$\text{area}^*(\mathcal{J}\text{nf}(P)) = \sum_{\substack{u \in P(\mathbb{Z}^2), \\ V \in \mathcal{J}_u(P), V \neq P}} \text{area}(d(V)) + \text{area}(d(P)) \geq \text{area}(d(P)) + \frac{1}{2} \sum_{u \in P(\mathbb{Z}^2)} \text{def}_u(d(P))^2,$$

and the latter expression is at least $\frac{3}{8}m^2$ by Lemma 1.8.2.

Similarly, by Lemma 1.8.3 we get

$$\text{area}(\mathcal{J}\text{nf}(P)) \geq 2 \cdot \text{area}(d(P)) + \frac{1}{2} \sum_{u \in P(\mathbb{Z}^2)} \text{def}_u(d(P))^2 \geq \frac{1}{2}m^2. \quad \square$$

1.10 Discussion

“The forceps of our minds are clumsy forceps,
and crush the truth a little in taking hold of it.”

H. G. Wells

In this section we show that a point of multiplicity m can impose fewer than $\frac{m(m+1)}{2}$ linearly independent conditions on the coefficients of the equation of a curve. Also, we summarize what is known about tropical points of multiplicity m .

1.10.1 Tropical points of multiplicity m

The aim of the present work was to improve the understanding of the combinatorics of tropical singular points.

For a tropical curve H , if a point P is of multiplicity at least m in the \mathbb{K} -extrinsic sense (Def. 1.1.2), then P is of multiplicity at least m in the intermediate sense (Def. 1.6.7); see Lemma 1.6.8.

Question 7. Is it true that for each m -thick (Def. 1.2.26) set $B \subset \mathbb{Z}^2$, there exists a polynomial $G \in \mathbb{Q}[x, y]$ defining the curve C' such that $\mu_{(1,1)}(C') \geq m$ and $\text{ConvHull}(\text{supp}(G)) = \text{ConvHull}(B)$?

As it is shown in Example 1.4.2, the answer is “no”.

We say that a tropical curve H can be lifted over a field \mathbb{K} if there exists a curve C' over \mathbb{K} such that $\text{Trop}(C') = H$. Let a point $P \in H$ be of multiplicity m in the \mathbb{K} -extrinsic sense for some valuation field \mathbb{K} . Suppose that H can be lifted over another field \mathbb{K}' of the same characteristic.

Question 8. Is it true that the point P is of multiplicity m in the \mathbb{K}' -extrinsic sense? As far as the author knows, this is an open problem (though it should be not very difficult).

For a tropical curve H , if a point $P \in H$ is of multiplicity at least m in the intermediate sense, then P is of multiplicity at least m in the intrinsic sense (Def. 1.7.4); see Proposition 1.9.17.

Note that the method in Proposition 1.4.3, which allows us to verify the definition in the extrinsic sense, requires information about all the valuations of the coefficients of the equation of the tropical curve H . Therefore, we have to know even those coefficients which can be perturbed without changing H . Hence, given only a tropical curve H , the verification of Def. 1.1.2 is not straightforward.

On the other hand, it is enough to know only the dual subdivision of the Newton polygon for H in order to verify the definition in the intrinsic sense (Def. 1.7.4). The multiplicity in the intrinsic sense of a point $P \in H$ remains the same if we change the lengths of the edges of H . Quite the contrary, for Def. 1.6.7 of multiplicity in the intermediate sense, the lengths of the edges of H are important because we operate with the extended Newton polyhedron $\tilde{\mathcal{A}}$; see also Remark 1.2.12.

So, if a point P is a point of multiplicity m in the extrinsic sense, then P satisfies some necessary conditions, for example, estimates in the Exertion Theorems hold and can be easily verified. Nevertheless an ambiguity remains: it is possible that a lot of the points on an edge E are of multiplicity m in the extrinsic sense, but we cannot realize them as tropicalizations of m -fold points simultaneously; see examples in [106, 107]. See also Proposition 1.9.19 and Lemma 3.3.19 for the case where we can prove that the position of P is unique. See also Section 3.4.4 for an example of an application of tropical modifications to m -fold points.

Chapter 2

Tropical approach to Nagata's conjecture in positive characteristic

Suppose that there exists a hypersurface with the Newton polytope Δ , which passes through a given set of subvarieties. Tropical geometry provides a tool for visualizing *the subsets* of Δ , “influenced” by these subvarieties. We prove that a weighted sum of the volumes of these subsets estimates the volume of Δ from below.

As a particular application of this method we consider a planar algebraic curve C which passes through generic points p_1, \dots, p_n with prescribed multiplicities m_1, \dots, m_n . Suppose that the minimal lattice width $\omega(\Delta)$ of the Newton polygon Δ of C is at least $\max(m_i)$. Using tropical floor diagrams (i.e. degeneration of p_1, \dots, p_n on a line) we prove that

$$\text{area}(\Delta) \geq \frac{1}{2} \sum_{i=1}^n m_i^2 - \frac{1}{2} \max\left(\sum_{i=1}^n s_i^2 \mid s_i \leq m_i, \sum_{i=1}^n s_i \leq \omega(\Delta)\right).$$

In the case $m_1 = m_2 = \dots = m \leq \omega(\Delta)$ this estimate becomes $\text{area}(\Delta) \geq \frac{1}{2}(n - \frac{\omega(\Delta)}{m} - 1)m^2$. That gives $d \geq (\sqrt{n} - \frac{1}{2} - \frac{1}{\sqrt{n}})m$ for the curves of degree d , if $n \geq 4$.

Note that, instead of usual approach, we consider an arbitrary toric surface (because of arbitrary Δ) and our ground field is an infinite field of any characteristic, or a finite field large enough. The reason is the latter constraint is that it is not a priori clear what is *a collection of generic points* in the case of a finite field. We construct such collections for fields big enough, what may be also interesting for code theory.

2.1 Main Theorem and a discussion around Nagata's conjecture

It is simple to find a polynomial in one variable with prescribed values at given points. A bit more involved is to find a polynomial in many variables with prescribed values at given points or to find a polynomial in one variable with prescribed higher derivatives at given points. Each of the conditions appeared above imposes one linear constraint on the polynomial's coefficients. Therefore the only difficulty is to prove the linear independence of these constraints.

One can generalize this question: given natural numbers m_1, m_2, \dots, m_n and a set of varieties $X_1, X_2, \dots, X_n \subset \mathbb{F}^k$ (where \mathbb{F} is an infinite field of any characteristic), we are wondering if there exists a hypersurface $Y \subset \mathbb{F}^k$ (with a given Newton polytope Δ) which passes through each of X_i with multiplicity $m_i \in \mathbb{N}$ respectively. That is not just arbitrary chosen problem: once discussed smooth varieties we inevitably fall into the realm of singular varieties, where a rather important problems is to find explicit examples. A particular way to pick a variety is to prescribe it by the above incidence relations.

This paper promotes the tropical point of view on singularity theory. We define *the subsets* $\mathfrak{Infl}(X_i)$ of Δ , “influenced” by each of X_i . These subsets can overlap, but no more than k at once (Corollary 2.2.18). Consider the case $k = \dim Y + 1 = 2$, i.e. Y is an algebraic curve and each of X_i is a point.

Definition 2.1.1. The lattice width $\omega_u(\Delta)$ of a polygon $\Delta \subset \mathbb{Z}^2$ in a direction $u \in P(\mathbb{Z}^2)$ is $\max_{x, y, \in \Delta} (u_1, u_2) \cdot (x - y)$, where $(u_1, u_2) \in \mathbb{Z}^2$ is any representative (Definition 1.2.24) of the direction u .

Definition 2.1.2. The minimal lattice width $\omega(\Delta)$ of a polygon $\Delta \subset \mathbb{Z}^2$ is $\min_{u \in P(\mathbb{Z}^2)} \omega_u(\Delta)$.

Definition 2.1.3. For a set of positive integer numbers m_1, m_2, \dots, m_n we define

$$S(m_1, \dots, m_n, k) = \frac{1}{2} \max \left(\sum_{i=1}^n s_i^2 \right) \quad (2.1)$$

where we maximize by all sets of numbers $\{s_i\}_{i=1}^n$ with $0 \leq s_i \leq m_i, \sum_{i=1}^n s_i \leq k$.

Example 2.1.4. If $m_1 = m_2 = \dots = m_n = m, k = \lfloor \sqrt{n} \rfloor m$, then $S(m_1, \dots, m_n, k) = \frac{1}{2} \lfloor \sqrt{n} \rfloor m^2$.

Theorem 2.1.5. Let \mathbb{F} be an infinite field or a field big enough (see Lemma 2.3.9). If $\omega(\Delta) \geq \max(m_i)$ and for each set of points $p_1, p_2, \dots, p_n \in \mathbb{F}^2$ there is an algebraic curve $C \subset \mathbb{F}^2$ with the Newton polygon Δ , passing through p_1, p_2, \dots, p_n with multiplicities m_1, m_2, \dots, m_n correspondingly, then

$$\text{area}(\Delta) \geq \frac{1}{2} \sum_{i=1}^n m_i^2 - S(m_1, m_2, \dots, m_n, \omega(\Delta)). \quad (2.2)$$

Corollary 2.1.6. If $m_1 = m_2 = \dots = m_n = m, \omega(\Delta) = \lfloor \sqrt{n} \rfloor m$, then $\text{area}(\Delta) \geq \frac{1}{2} (n - \lfloor \sqrt{n} \rfloor) m^2$.

Let \mathbb{K} be the field $\mathbb{F}\{\{t\}\}$ of Puiseux series. That means, $\mathbb{F}\{\{t\}\} = \{ \sum_{\alpha \in I} c_\alpha t^\alpha \mid c_\alpha \in (\mathbb{F}^*), I \subset \mathbb{Q} \}$, where t is a formal variable and I is a well-ordered set (each its nonempty subset has a least element). Define a *valuation map* $\text{val} : \mathbb{K} \rightarrow \mathbb{T}$ by the rule $\text{val}(\sum_{\alpha \in I} c_\alpha t^\alpha) := -\min\{\alpha \mid \alpha \in I, c_\alpha \neq 0\}$ and $\text{val}(0) := -\infty$. Different versions of Puiseux series are listed in [109, 146].

We will prove that the above theorem holds over the valuation field \mathbb{K} . We use the nature of a singular point’s influence on the Newton polygon of a curve (see Chapter 1 as an extension version of [81]) and tropical floor diagrams [30, 31]. Tropical floor diagrams illustrate the process of a degeneration of the points p_1, \dots, p_n on a line, in a sense it is a tropical version of the Horace method [58]. The idea of the proof is the following. While degenerating p_1, p_2, \dots, p_n onto a line,

we see the following behavior (Figure 2.2) of the points on the tropical picture. Each point of the multiplicity m_i splits into two parts $m_i = s_i + r_i$, such that $\sum_{i=1}^n s_i \leq \omega(\Delta)$. Furthermore, we choose a part of $\mathfrak{Inf}(p_i)$ for each $i = 1, \dots, n$; these parts do not intersect and the area of such a part for a point p_i is at least $\frac{1}{2}(m_i^2 - s_i^2)$.

Then, using a substitution $t \rightarrow a \in \mathbb{F}, \mathbb{K} \rightarrow \mathbb{F}$ we prove the *Detropicalization lemma*. It says that there is a constant $N \in \mathbb{N}$ such that if the cardinality of \mathbb{F} is at least N (which is always the case if \mathbb{F} is infinite), then Theorem 2.1.5 holds for \mathbb{F} . In small fields we can not find a sufficiently generic collection of points. The constant N , then, depends on $\max(m_i), \Delta$ and $\text{char}(\mathbb{F})$. This reasoning could be of a particular interest to code theory, see Section 2.5.

Corollary 2.1.7. Suppose that $m_1 = m_2 = \dots = m_n = m \leq \omega(\Delta)$. Therefore, under the conditions of Theorem 2.1.5 we have $\text{area}(\Delta) \geq \frac{1}{2}(n - \frac{\omega(\Delta)}{m} - 1)m^2$.

Proof. Seeking for the minimum of $\sum_{i=1}^n (m^2 - s_i^2)$ under conditions $\sum s_i = \omega(\Delta), s_i \leq m$ we see that the minimum is attained when

$$s_i = m, \text{ if } 1 \leq i \leq k, \text{ and } 0 \leq s_{k+1} < m, \text{ and } s_{>k+1} = 0.$$

In our case, write $\omega(\Delta) = mk + k', 0 \leq k' < m$. Then, $\sum_{i=1}^n (m^2 - s_i^2) \geq (n - k - 1)m^2 + (m - k')^2$. Therefore,

$$\text{area}(\Delta) \geq \frac{1}{2}((n - k - 1)m^2 + (m - k')^2) \geq \frac{1}{2}(n - \omega(\Delta)/m - 1)m^2.$$

□

2.1.1 Nagata's conjecture.

Let us fix a field \mathbb{F} . For a point $p = (p_1, p_2) \in \mathbb{F}^2$ we denote by I_p the ideal of the point p , namely $I_p = \langle x - p_1, y - p_2 \rangle$.

Definition 2.1.8. Consider an algebraic curve C given by an equation $F(x, y) = 0, F \in \mathbb{F}[x, y]$. We say that p is of *multiplicity at least m* for C (and write $\mu_p(C) \geq m$), if $F \in (I_p)^m$ in the local ring of p .

In the most non-degenerate case p being a point of multiplicity m on C means that there are at least m branches of C passing through p . For the fields of zero characteristic, the fact $F \in (I_p)^m$ is equivalent to the fact that all the partial derivatives of F up to order $m - 1$ vanish at p .

Example 2.1.9. Consider a planar algebraic curve C of degree d given by an equation $F(x, y) = 0$, where

$$F(x, y) = \sum_{i,j \geq 0, i+j \leq d} a_{ij} x^i y^j$$

The point $p = (0, 0)$ is of multiplicity m for C if and only if for all $i, j \geq 0$ with $i + j < m$ we have $a_{ij} = 0$. As a consequence, for each point $p \in \mathbb{F}^2$ the condition “ p is a point of multiplicity at least m for C ” can be rewritten as a system of $\frac{m(m+1)}{2}$ linear equations in the coefficients $\{a_{ij}\}$ of F .

Let p_1, \dots, p_n be a collection of $n > 9$ points in \mathbb{F}^2 and $m_1, \dots, m_n \in \mathbb{N}$. We are looking for the minimal degree d_{min} of an algebraic curve passing through p_1, \dots, p_n with multiplicities at least m_1, \dots, m_n respectively.

One can naively calculate the expected dimension $\epsilon \dim(d, m_1, \dots, m_n)$ of the space \mathfrak{S} of the curves of degree d satisfying the hypothesis above: each singular point freezes $\frac{m(m+1)}{2}$ degrees of freedom, i.e. imposes $\frac{m(m+1)}{2}$ constraints on the coefficients of the curve equation. Therefore,

$$\epsilon \dim(d, m_1, \dots, m_n) = \max \left(-1, \frac{d(d+3)}{2} - \sum_{i=1}^n \frac{m_i(m_i+1)}{2} \right).$$

The actual dimension of \mathfrak{S} is always at least the expected one, because all the constraints are linear. However, sometimes even for a generic choice of the set of points p_1, p_2, \dots, p_n the actual dimension is strictly greater than the expected.

Example 2.1.10. Let us consider two points p_1, p_2 . The minimal degree of a curve passing through p_1, p_2 with multiplicities m_1, m_2 is m_1 , if $m_1 \geq m_2$: it is the line passing through p_1 and p_2 taken with multiplicity m_1 . So the inequality $d_{min} \geq \frac{m_1+m_2}{\sqrt{2}}$ in the Nagata's conjecture is not satisfied as long as $m_2 > m_1(\sqrt{2} - 1)$. We see a similar situation for five points: one can draw a non-reduced conic through them.

As a reasonable estimate for d_{min} , Nagata's conjecture claims:

Conjecture 1. If $d \leq \frac{\sum_{i=1}^n m_i}{\sqrt{n}}$ and points $p_1, \dots, p_n, n > 9$ are chosen generically then $\dim \mathfrak{S} = -1$.
In other words, $d_{min} > \frac{\sum_{i=1}^n m_i}{\sqrt{n}}$.

The case $n = l^2$ had been proven by Nagata himself [124]. Now, even the case $n = 10$ and $m_1 = m_2 = \dots = m_{10} = m$ is under exhaustive study ([45]), but has not yet been proven. The similar questions in higher dimensions are widely open (cf. [21],[55]). The pictures appeared in our approach are somewhat similar to those in [132], though the relation is not direct.

Historically Nagata's conjecture appeared as a tool (with $n = 16$) to disprove Hilbert 14th problem. There also exists Segre-Harbourne-Hirschowitz conjecture which basically says that if the expected dimension $\epsilon \dim$ of \mathfrak{S} is not equal to the actual one, then the linear system \mathfrak{S} contains a rational curve in its base locus. The reader is kindly referred to look into surveys [43, 44, 74, 121] for an introduction to Nagata's conjecture and related topics.

In view of Theorem 2.1.5 the following three results should be mentioned:

Theorem ([166], Xu). *If C is a reduced and irreducible curve passing through generically chosen points $p_1, p_2, \dots, p_n \in \mathbb{C}P^2$ with multiplicities m_1, m_2, \dots, m_n respectively, then the estimate $d^2 \geq \sum_{i=1..n} m_i^2 - \min(m_i)$ holds.*

Unlike Xu's theorem, in Theorem 2.1.5 we consider curves with arbitrary Newton polygons, defined over fields of any characteristic. Furthermore, our curves are allowed to be reducible and non-reduced.

Theorem ([3], Alexander, Hirschowitz). *The dimension of the space of degree $d > 2$ hypersurfaces in $\mathbb{C}P^k (k \geq 3)$, passing through generic points p_1, p_2, \dots, p_n with multiplicities $m_1 = \dots = m_n = 2$, is the expected one except the cases $(k, d, n) = (2, 4, 5), (3, 4, 9), (4, 4, 14), (4, 3, 7)$.*

Using the methods of this Chapter and classification in [107], we can prove (Remark 2.3.7) that the volume V of the Newton polytope of a surface in $\mathbb{C}P^3$ with n two-fold points in **general** position satisfies $n \leq 2V$. Using the above theorem we can obtain a better estimate. Indeed, for the case of hypersurfaces of degree d in $\mathbb{C}P^3$ the above theorem gives $4n \leq (d+1)(d+2)(d+3)/6$, i.e. $n \sim V/4$.

Theorem ([4], Alexander, Hirschowitz). *For each field \mathbb{F} , the dimension of degree d hypersurfaces in $\mathbb{F}P^k$ passing through generic points p_1, p_2, \dots, p_n with multiplicities m_1, m_2, \dots, m_n is the expected one if $d \gg \max m_i$.*

We expect that our approach can be extended to the cases $k \geq 3$ and $m_i > 2$. Such an extension would lead to explicit degree estimates.

2.2 Preliminaries in tropical geometry

In this section we recall some definitions and set up the notation. We discuss the notion of a set of points in \mathbb{Z}^k in *tropical general position* with respect to a polytope Δ . We use this construction in the following sections. We refer the reader to [29],[102] for a general introduction to tropical geometry.

Let \mathbb{T} denote $\mathbb{Q} \cup \{-\infty\}$, and \mathbb{K} be a field with a valuation map $\text{val} : \mathbb{K} \rightarrow \mathbb{T}$. We use the convention $\text{val}(a+b) \leq \text{val}(a) + \text{val}(b)$, $\text{val}(0) = -\infty$. Usually \mathbb{T} is called *tropical semi-ring*.

Consider a hypersurface $Y \subset \mathbb{K}^k$. Let Y be given by an equation

$$F(x_1, x_2, \dots, x_k) = 0,$$

$$F = \sum_{I \in \mathcal{A}} c_I x^I, I = (i_1, i_2, \dots, i_k), c_I \neq 0.$$

In such case $\Delta = \text{ConvexHull}(\mathcal{A})$ is called *the Newton polytope* of Y .

The Newton polytope of F is provided with a subdivision dependent on the coefficients of F . Namely, consider the extended Newton polytope of Y ,

$$\tilde{\Delta} = \text{ConvexHull}\{(I, x) \in \mathbb{Z}^k \times \mathbb{T} \mid I \in \mathcal{A}, x \leq \text{val}(c_I)\}.$$

Projection of the faces of the extended Newton polytope $\tilde{\Delta}$ onto the Newton polytope Δ defines a subdivision of Δ .

We give a definition of the tropicalization of Y , based on its equation $F(x) = \sum_{I \in \mathcal{A}} c_I x^I$. For a *weight* $\omega = (w_1, w_2, \dots, w_k) \in \mathbb{T}^k$ we consider the *weight function* $\omega(cx_1^{i_1} x_2^{i_2} \dots x_k^{i_k}) := \text{val}(c) + i_1 w_1 + i_2 w_2 + \dots + i_k w_k$. Then we define initial part $\text{in}_\omega(F)$ as the ω -maximal part of F . Now we define $\text{Trop}(Y)$ to be the set of all weights ω such that $\text{in}_\omega(F)$ is not a monomial.

We can describe the above subdivision of Δ : a point $I \in \Delta$ is a vertex of the subdivision if there exists such a weight $\omega \in \mathbb{T}^k$ that $\text{in}_\omega(F) = c_I x^I$. An interval $I_1 I_2$ between two vertices $I_1, I_2 \in \Delta$ is an edge of the subdivision if there exists a weight ω such that $\text{in}_\omega(F) = \sum_{I \in J} c_I x^I$ where the convex hull of J is the interval $I_1 I_2$, etc.

Remark 2.2.1. In general, each cell of the subdivision of Δ is of the type

$$\Delta_\omega = \text{ConvexHull}(\text{support}(\text{in}_\omega(F)))$$

for some $\omega \in \mathbb{T}^k$.

Remark 2.2.2. If Y is a hypersurface, then $\text{Trop}(Y) \subset \mathbb{T}^k$ is a polyhedral complex of codimension one. For each cell $\Delta_\omega \subset \Delta$ we define $d(\Delta_\omega) = \{\omega' \in \mathbb{T}^l \mid \Delta_\omega = \Delta_{\omega'}\}$.

This map d provides the following correspondence: the vertices of the subdivision of Δ correspond to the connected components of the complement of $\text{Trop}(Y)$, the edges of the subdivision correspond to the faces of $\text{Trop}(Y)$ of maximal codimension, 2-cells of the subdivision correspond to faces of codimension 1 in $\text{Trop}(Y)$, etc.

Remark 2.2.3. If $X \subset \mathbb{K}^n$ is a variety of higher codimension, we define its tropicalization $\text{Trop}(X)$ as follows. Let I be the ideal of X . Let $\text{in}_\omega(I)$ be the ideal generated by the elements $\text{in}_\omega(f)$, $f \in I$. Then, by definition, $\omega \in \text{Trop}(X)$ if and only if $\text{in}_\omega(I)$ is monomial free.

2.2.1 Influenced subsets in the Newton polytope

Let Y be a hypersurface in \mathbb{K}^n with the Newton polytope Δ . In this subsection, for a given subvariety $X \subset Y$, we define the set $\mathfrak{V}(\text{Trop}(X))$ of vertices of $\text{Trop}(Y)$ and the subset $\mathfrak{Inf}(X) \subset \Delta$. These definitions generalize the definitions given in Section 1.6.

Definition 2.2.4. We denote by $P(\mathbb{Z}^k)$ the set of all directions in \mathbb{Z}^k . An affine hyperplane with a normal direction $u \in P(\mathbb{Z}^k)$ is a set $\{x \in \mathbb{R}^k \mid u \cdot x = c\}$ with some $c \in \mathbb{R}$. Cf. Definition 1.2.24.

Let Q be a subset of $\text{Trop}(Y)$.

Definition 2.2.5. Let $l_Q(u)$ be the affine hyperplane in \mathbb{R}^k with normal direction u , containing the set Q , if exists, and $l_Q(u) = \emptyset$, otherwise. Let $P(\Delta) \subset P(\mathbb{Z}^k)$ be the set of the directions of the vectors $\{\overline{IJ} \mid I, J \in \Delta\}$ between the lattice points in Δ . The connected component of Q in the intersection $\text{Trop}(Y) \cap \bigcup_{u \in P(\Delta)} l_Q(u)$ is called *the star* $\text{Star}^\Delta(Q)$ of Q in $\text{Trop}(Y)$.

Example 2.2.6. Let $Y \subset \mathbb{K}^2$ be a curve. If Q is vertex of $\text{Trop}(Y)$, then $\text{Star}^\Delta(Q)$ is the connected component of Q in the intersection of $\text{Trop}(Y)$ with the union of the lines spanned by the edges of $\text{Trop}(Y)$ through Q . If $Q \in \text{Trop}(Y)$ is not a vertex of $\text{Trop}(Y)$, then $\text{Star}^\Delta(Q)$ is the connected component of Q in the intersection of $\text{Trop}(Y)$ with the line spanned by the unique edge of $\text{Trop}(Y)$ through Q .

Definition 2.2.7. Let $\mathfrak{V}(Q)$ be the set of the vertices of $\text{Trop}(Y)$ in $\text{Star}^\Delta(Q)$.

The star $\text{Star}^\Delta(Q)$ is naturally stratified on cells, we provide each point in $\text{Star}^\Delta(Q)$ with a multiplicity corresponding to the codimension of its stratum.

Definition 2.2.8. Namely, for a point $V \in \text{Star}^\Delta(Q)$ the natural number $\text{mult}_Q(V)$ is the dimension of the linear span of the directions $u \in P(\Delta)$ such that the hyperplane through V with the normal direction u contains Q .

Example 2.2.9. If $\Delta \subset \mathbb{Z}^2$ and Q is a point, then $\text{Star}^\Delta(Q)$ is a union of intervals emanating from Q . In this case $\text{mult}_Q(Q) = 2$ and $\text{mult}_Q(V) = 1$ for $V \in \text{Star}^\Delta(Q)$, $V \neq Q$.

Each tropical variety $\text{Trop}(X)$ is naturally decomposed into vertices, edges, faces, etc, $\text{Trop}(X) = \bigcup X^{p,q}$ where p is the dimension of the cell $X^{p,q}$ and q is its number. If X would be a hypersurface, then each cell of $\text{Trop}(X)$ would be an equivalence class of some $\omega \in \text{Trop}(X)$, with the equivalence

relation $\omega \sim \omega'$ iff $\Delta_\omega = \Delta_{\omega'}$, see Remark 2.2.1. In general, this subdivision is incorporated into the definition of a tropical variety.

Let $X \subset Y$, then $\text{Trop}(X) \subset \text{Trop}(Y)$.

Definition 2.2.10. Define $\mathfrak{J}(\text{Trop}(X)) = \bigcup \mathfrak{J}(X^{p,q})$. Also, define the star of the variety $\text{Trop}(X)$ as

$$\text{Star}^\Delta(\text{Trop}(X)) = \bigcup \text{Star}^\Delta(X^{p,q}).$$

Definition 2.2.11. For a vertex $V \in \mathfrak{J}(\text{Trop}(X))$ we define its multiplicity $\text{mult}_{\text{Trop}(X)}(V)$ as $\max_{X^{p,q}} \text{mult}_{X^{p,q}}(V)$, i.e. we take the maximum of the multiplicities of V with respect to the cells in the natural cell decomposition of $\text{Trop}(X)$.

The distinguished domain in Δ , corresponding to X , is

$$\mathfrak{Jnf}l(X) = \bigcup_{V \in \mathfrak{J}(\text{Trop}(X))} d(V),$$

where $d(V)$ is the cell (of the maximal dimension) of Δ , dual to the vertex V of $\text{Trop}(Y)$.

Definition 2.2.12. By $\text{Volume}(\mathfrak{Jnf}l(\text{Trop}(X)))$ we denote the sum of volumes (with multiplicities, see Definition 2.2.11) of the cells in the subdivision of Δ , dual to the vertices in $\mathfrak{J}(\text{Trop}(X))$, i.e.

$$\text{Volume}(\mathfrak{Jnf}l(\text{Trop}(X))) = \sum_{V \in \mathfrak{J}(\text{Trop}(X))} \text{mult}_{\text{Trop}(X)}(V) \cdot \text{Volume}(d(V)).$$

Example 2.2.13. Consider the two dimensional case, $X = (x_1, x_2) \in \mathbb{K}^2$ is a point such that $\text{Trop}(X) = P = (\text{val}(x_1), \text{val}(x_2)) \in \mathbb{T}^2$. If P is a vertex of $\text{Trop}(Y)$, then

$$\text{area}(\mathfrak{Jnf}l(P)) = 2 \cdot \text{area}(d(P)) + \sum_{\substack{V \in \mathfrak{J}(P), \\ V \neq P}} 1 \cdot \text{area}(d(V)),$$

cf. with the definition of $\text{area}(\mathfrak{Jnf}l(P))$ in Section 1.6.

Question 9. The dual object for a hypersurface is its Newton polytope. The dual objects for the varieties of higher codimension are so-called *generalized Newton polytopes* or *valuations* in the McMullen polytope algebra [28, 153]. In fact, $\mathfrak{Jnf}l$ for a variety Y of any codimension can be defined in a similar way, but it is not clear what is the right substitute for $\text{Volume}(\mathfrak{Jnf}l(P))$ in this case.

2.2.2 General position of points with respect to the Newton polygon

Definition 2.2.14. A collection of tropical subvarieties $Z_1, Z_2, \dots, Z_n \in \mathbb{T}^k$ is *in general position* with respect to a polytope Δ if for each collection of indices $i_1 < i_2 < \dots < i_{k+1}$ the intersection $\text{Star}^\Delta(Z_{i_1}) \cap \text{Star}^\Delta(Z_{i_2}) \cap \dots \cap \text{Star}^\Delta(Z_{i_{k+1}})$ is empty.

Let T_v be the translation $\mathbb{T}^k \rightarrow \mathbb{T}^k$ by the vector v .

Proposition 2.2.15. For a polytope Δ and given set $Z_1, Z_2, \dots, Z_n \in \mathbb{T}^k$ of tropical varieties there exists a set of vectors $v_1, v_2, \dots, v_n \in \mathbb{Z}^k$ such that the tropical varieties $T_{v_i}(Z_i)$ are in general position with Δ .

Proof. Indeed, each star $\text{Star}^\Delta(Z_i)$ consists of a finite union of hyperplanes. Therefore, we can choose a vector $v_1 = 0$ and $v_2 \in \mathbb{Z}^k$ such that the intersection of each two hyperplanes L_1, L_2 from the collections $\text{Star}^\Delta(Z_1)$ and $\text{Star}^\Delta(T_{v_2}(Z_2))$ respectively is a linear subspace of dimension at most $k - 2$. Then we choose a vector $v_3 \in \mathbb{Z}^k$ such that the intersection of each pair of hyperplanes from different collections $\text{Star}^\Delta(T_{v_i}(Z_i)), i = 1, 2, 3$ is of dimension at most $k - 2$ and the intersection of a triple of hyperplanes from different collections is of dimension at most $k - 3$, etc. \square

Corollary 2.2.16. There exists a constant N depending on Δ, n, k and the total number of cells in the natural subdivisions of Z_1, Z_2, \dots, Z_n such that the vectors v_1, \dots, v_n can be chosen in such a way that $|v_i| \leq N$ for each i . \square

Corollary 2.2.17. For each $n, k \in \mathbb{N}, \Delta$ there exists a set of points $P_1, P_2, \dots, P_n \in \mathbb{Z}^k \subset \mathbb{T}^k$ in general position with respect to Δ .

Proof. We start from $P_1 = P_2 = \dots = P_n = 0 \in \mathbb{Z}^n$. Then we use the fact that \mathbb{Z}^k is not coverable by a finite number of linear spaces of dimension $k - 1$ and proceed as in Proposition 2.2.15. \square

Corollary 2.2.18. For a collection of tropical varieties $Z_1, Z_2, \dots, Z_n \in \mathbb{T}^k$ in general position with respect to Δ , the sum $\sum_{i=1}^n \text{Volume}(\mathfrak{Inf}(Z_i))$ is at most $k \cdot \text{Volume}(\Delta)$.

Proof. This follows from the definitions of a general position (Definition 2.2.14) and multiplicities in the volume of \mathfrak{Inf} (Definition 2.2.12). \square

2.3 An estimate of a singular points' influence of the Newton polygon of a curve

Let C be a curve over \mathbb{K} with the Newton polygon Δ such that $\omega(\Delta) \geq m$.

Theorem 2.3.1 (Section 1.6). Suppose that a point $p = (p_1, p_2) \in (\mathbb{K}^*)^2$ is of multiplicity m for this curve C , $P = (\text{val}(p_1), \text{val}(p_2))$. Then,

$$\text{area}(\mathfrak{Inf}(P)) \geq \frac{m^2}{2}. \quad (2.3)$$

Example 2.3.2. Consider a curve C given by the equation $(x - 1)^k(y - 1)^{m-k} = 0$, take $p = (1, 1)$. Clearly, $\mu_p(C) = m$, but the Newton polygon Δ of C violates the condition $\omega(\Delta) \geq m$, and the inequality $\text{area}(\mathfrak{Inf}(\text{val}(p))) = 2k(m - k) \geq \frac{m^2}{2}$ does not hold except the case $k = m/2$.

Consider now a curve C passing through $p_1, p_2, \dots, p_n \in \mathbb{K}^2, n \geq 2$ with multiplicities m_1, m_2, \dots, m_n respectively. Suppose that the Newton polygon Δ of C has the minimal lattice width $\omega(\Delta)$ at least $\max(m_i)$.

Lemma 2.3.3. If the points $\text{val}(p_i) \in \mathbb{Z}^2, i = 1, \dots, n$ are in general position with respect to Δ (see Lemma 2.2.15 and its corollaries), then the area of Δ satisfies the inequality

$$\text{area}(\Delta) \geq \frac{1}{4} \sum_{i=1}^n m_i^2. \quad (2.4)$$

Proof. Theorem 2.3.1 and Corollary 2.2.18 imply that

$$\sum_{i=1}^n \frac{m_i^2}{2} \leq \sum \text{area}(\mathfrak{Infl}(P_i)) \leq 2 \cdot \text{area}(\Delta).$$

□

Corollary 2.3.4. Consider curves of degree d , in lieu of fixing the Newton polygon. Then, we have $d^2 \geq \frac{1}{2} \sum_{i=1}^n m_i^2$ if $d \geq \max(m_i)$.

Proof. Indeed, consider any curve under the above hypothesis. The equation of a curve of degree d may contain some monomials with zero coefficients. So, if the minimal lattice width of the actual Newton polygon of C is at least $\max(m_i)$, then we are done. If it is not the case, we apply the following lemma.

Lemma 2.3.5 (Lemma 1.2.28). If $\mu_{(1,1)}(C) = m$ and $\omega_u(\mathcal{A}) = m - a$ for some $a > 0, u \sim (u_1, u_2)$, then C contains a rational component parametrized as (s^{u_1}, s^{u_2}) .

If C has a rational component of this given type, then C is reducible, and we can perturb this component, because it does not pass through others p_i . After that this component is no longer of the type (as^k, bs^l) , and this perturbation does not change the degree of the curve. □

Let P be a vertex of $\text{Trop}(C)$ and the edge E through P is horizontal. Suppose that $\omega_{(1,0)}(d(P)) = a \leq m$, i.e. a is the length of the projection of $d(P)$ onto the x -axis.

Lemma 2.3.6 (Lemma 1.9.20). If $\mu_p(C) \geq m, P = \text{Val}(p)$ is a vertex of $\text{Trop}(C)$, and $u = (1, 0)$, then

$$\sum_{V \in \mathfrak{I}_P(u), V \neq P} \text{area}(d(V)) \geq \frac{1}{2}(m - a)^2. \quad (2.5)$$

We use this lemma for the horizontal direction $(1, 0)$ (in Lemma 1.9.20 and [81], the direction u is any direction). In our case $\mathfrak{I}(u)$ is the set of vertices of $\text{Trop}(C)$, lying in the connected component of P in the intersection of $\text{Trop}(C)$ with the straight horizontal line through P , see Figure 2.1.

Remark 2.3.7. Using the classification of possible combinatorial neighborhoods of two-fold point P in a tropical surface in \mathbb{T}^3 ([107]) we can prove that $\text{Volume}(\mathfrak{Infl}(P)) \geq 2$ in such a case. With a few work, that gives an estimate $n \leq \frac{d^3}{3}$ for the degree d of a surface with n 2-fold points, but the theorem of Alexander and Hirschowitz provides a better estimate $n \leq \frac{(d+1)(d+2)(d+3)}{24}$.

Question 10. So, in order to beat the theorem of Alexander and Hirschowitz we need to prove that $\text{Volume}(\mathfrak{Infl}(P)) \geq 16$ if P is an m -fold point for some m . This seems to be highly unrealistic since the combinatorics for $m = 2$ is already rather complicated. So, we need some new methods like in Chapter 1, but for higher dimensional case.

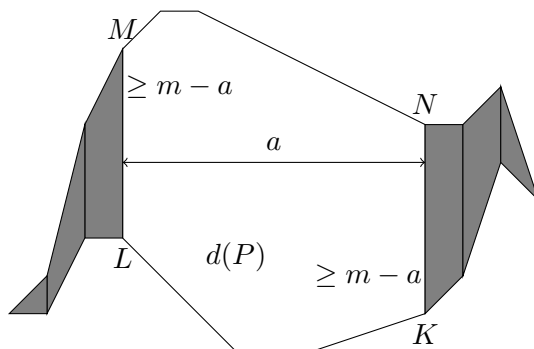

Figure 2.1: Dual picture to a singular point P on an edge. Since $\omega_{(1,0)}(d(P)) = a$, the lengths of LM and NK are at least $m - a$. The set $\bigcup d(Q)$ for $Q \in \mathfrak{I}_P((1,0)), Q \neq P$ is colored. The sum of the areas of the colored faces is at least $\frac{1}{2}(m - a)^2$.

Question 11. We expect that for a line L of multiplicity m inside a surface of degree d in $\mathbb{C}P^3$ the estimate $\text{Volume}(\mathfrak{Infl}(\text{Trop}(L))) \geq cm^2d$ holds with some constant c . This would give an estimate for the degree of a surface with multiple two-fold points and m -fold lines.

Question 12. We can study similar question for varieties of codimension two (see also [75] for other questions about varieties of small codimensions). Consider a tropical (i.e. balanced) two-dimensional fan L in \mathbb{R}^4 . Suppose that the tropical stable intersection of L with each plane of rational slope is at least m . Is it true that there exists a constant c such that $L \cdot L \geq cm^2$ in this case? One of the possible directions to attack this problem is via tropical Chow polytopes, see [61].

2.3.1 Detropicalization Lemma

An algebraic statement over an algebraically closed field sometimes implies the same statement over all fields of the same characteristic. Tropical geometry may help in such a situation, see [160]. Another application of tropical geometry in number theory is [83]. This section describes a particular application of this principle to our estimate.

We use the field $\mathbb{K} = \mathbb{F}\{\{t\}\}$. Note that each element $a \in \mathbb{F}$ defines a map $\nu_a : \mathbb{K} \rightarrow \mathbb{F}$ by means of the substitution $t = a$. However, ν_a is not well-defined on the whole \mathbb{K} , but we can compute it on the elements of the type $\frac{f(t)}{g(t)}$ where $f, g \in \mathbb{F}[t]$ and $g(a) \neq 0$.

Let us recall how to *tropicalize* the problem of curves' counting. We would like to count plane complex algebraic curves of given genus and degree, these curves are required to pass through a number of generic points $q_1, q_2, \dots, q_l \in \mathbb{C}P^2$ (l is chosen in such a way that the number of curves is expected to be finite). Since the points are generic we can force them to go to infinity with some asymptotics, say $q_i = (t^{x_i}, t^{y_i})$. Then we consider the limits of the constructed curves C_t under the function $\log_t(|z|) : \mathbb{C}^2 \rightarrow \mathbb{R}^2$. This is more or less the same as if we considered a curve over $\mathbb{C}\{\{t\}\}$ passing through $(t^{x_i}, t^{y_i}) \in \mathbb{C}\{\{t\}\}$ and then have taken its non-Archimedean amoeba. Hence we started from \mathbb{C} , lifted to $\mathbb{C}\{\{t\}\}$, and finally descended to \mathbb{T} .

Detropicalization is the opposite process: firstly, we prove something in \mathbb{T} , then lift the construction to $\mathbb{F}\{\{t\}\}$, and finally return to \mathbb{F} using ν_a .

Here we establish the following lemma.

Lemma 2.3.8. Let m_1, m_2, \dots, m_n be non-negative integers. Let Δ be a lattice polygon such that $\text{area}(\Delta) < \sum_{i=1}^n \frac{m_i^2}{4}$. Then, if the set of points $(x_i, y_i) \in \mathbb{T}^2$ is in general position with respect to Δ (Definition 2.2.14), then for each valuation field \mathbb{K} and points $p_1, p_2, \dots, p_n \in (\mathbb{K}^*)^2$ such that $\text{Val}(p_i) = (x_i, y_i)$ there is no curve C over \mathbb{K} with the Newton polygon Δ , with $\mu_{p_i}(C) \geq m_i, i = 1, \dots, n$.

Proof. Suppose that such a curve C exists. Then, consider $\text{Trop}(C)$. We know that in this case

$$\text{area}(\mathfrak{Infl}((x_i, y_i))) \geq \frac{m_i^2}{2}$$

for $i = 1, \dots, n$ and, therefore, $\sum_{i=1}^n \text{area}(\mathfrak{Infl}(x_i, y_i)) \geq \sum_{i=1}^n \frac{m_i^2}{4} \geq 2 \cdot \text{area}(\Delta)$. So, by Corollary 2.2.18 we arrived at a contradiction. \square

Lemma 2.3.9 (Detropicalization lemma). Let $\mathbb{K} = \mathbb{F}\{\{t\}\}$. Suppose that there is no curve C over \mathbb{K} with the Newton polygon Δ such that

$$\mu_{(t^{-x_i}, t^{-y_i})}(C) \geq m_i.$$

Then, there exists a constant N depending on $m_1, m_2, \dots, m_n, \Delta, \max x_i, \max y_i$ with the following property. If $|\mathbb{F}| \geq N$, then there exists $a \in \mathbb{F}$ such that there is no curve over \mathbb{F} with the Newton polygon Δ and $\mu_{(a^{-x_i}, a^{-y_i})}(C) \geq m_i$ for each $i = 1, \dots, n$.

Proof. Indeed, all the constraints imposed by the fact $\mu_p(C) \geq m$ are linear equations in the coefficients of the equation of C . Therefore the only reason why there is no solution for this system over Puiseux series and there is a solution over \mathbb{F} is that some minor of the matrix of the equations turns out to be 0 after substituting $t = a$. Thus, let us compute all needed minors before, they reveal to be polynomials in t with degrees depending on our data. Therefore the only condition for a is that a is not a root of some fixed polynomial of some bounded degree. Obviously, if $|\mathbb{F}|$ is big enough, then there exists such an a . \square

Remark 2.3.10. In a similar way we can detropicalize in other situations, if the conditions imposed on C reveal to be algebraic conditions on the coefficients of the equation of C .

2.4 Degeneration of tropical points to a line.

In this section, using tropical floor diagrams (see [29, 31]), we construct a special collection of tropical points which are in general position with respect to the Newton polygon Δ ; this construction gives another estimate for $\text{area}(\Delta)$.

Consider a tropical curve H given by $\text{Trop}(F) = \max_{(i,j)}(ix + jy + \text{val}(a_{ij}))$ where (i, j) runs over lattice points in a fixed Newton polygon Δ . We may assume that the minimal lattice width $\omega(\Delta)$ of Δ is attained in the horizontal direction. Let Δ is contained in the strip $\{(x, y) | 0 \leq y \leq N\}$. Let us choose points P_1, P_2, \dots, P_n on the line $l = \{(x, y) | y = \frac{1}{N+1}x\}$ which is almost horizontal, i.e. its

slope $\frac{1}{N+1}$ is less than any possible slope of non-horizontal edges of a curve with the given Newton polygon Δ .

Proposition 2.4.1. Suppose that each of the points P_1, P_2, \dots, P_n is not a vertex of H , and each P_i is lying on a horizontal edge E_i of H . In this case, for each $1 \leq i < j \leq n$ we have $\mathfrak{Infl}(P_i) \cap \mathfrak{Infl}(P_j) = \emptyset$.

Proof. Indeed, in this case the vertices in $\mathfrak{I}(P_i)$ are lying on the horizontal lines through P_i , and all P_i have different y -coordinates. □

Corollary 2.4.2. In the above case, $\sum_{i=1}^n \text{area}(\mathfrak{Infl}(P_i)) \leq \text{area}(\Delta)$. □

In general, the situation is not much worse than in the hypothesis of the above proposition. The line l is subdivided by intersections with H , each connected component of $l \setminus H$ corresponds to a monomial in $\text{Trop}(F)$, i.e. to a lattice point in Δ . Moving by l from left to right and marking corresponding lattice points in Δ we obtain a lattice path in Δ , which possesses the following property: each edge in this path is either vertical or has positive projection on the horizontal line.

If P_i is not a vertex of $\text{Trop}(C)$, and P_i belongs to an edge E_i of $\text{Trop}(C)$, then denote by s_i the length of the horizontal projection of $d(E_i)$. If P_i is a vertex of $\text{Trop}(C)$, then denote by s_i the length of the horizontal projection of $d(P_i)$.

Previous considerations shows that $\sum_{i=1}^n s_i \leq \omega(\Delta)$.

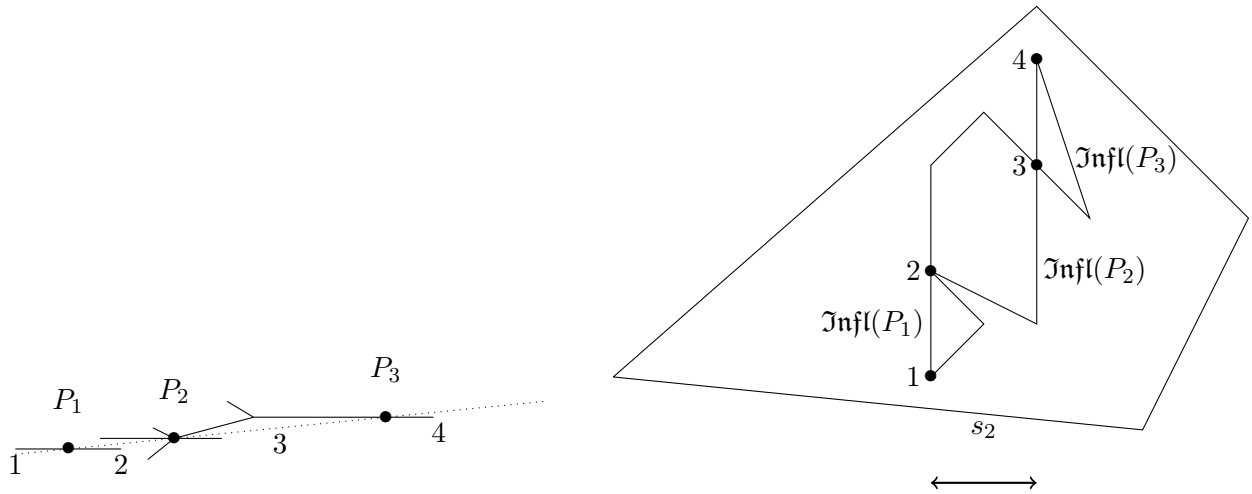

Figure 2.2: The first(top) picture represents a part of a tropical curve through points P_1, P_2, P_3 on an almost horizontal line. The second picture is dual to the first picture, we see the regions of influence of the points P_1, P_2, P_3 . The marked points 1, 2, 3, 4 represent the monomials which are maximal on the parts of the dotted line on the left picture. The lattice path 1, 2, 3, 4 is non-decreasing by the x -coordinate, therefore $\sum_{i=1}^n s_i \leq \omega_{(1,0)}(\Delta)$.

Proposition 2.4.3. In the above notation,

$$\frac{1}{2} \sum_{i=1}^n (m_i^2 - s_i^2) \leq \sum_{i=1}^n \left(\sum_{V \in \mathfrak{J}_{P_i}((0,1))} \text{area}(d(V)) \right) \leq \text{area}(\Delta).$$

Proof. The right inequality is trivial, because the sets $\mathfrak{J}_{P_i}((1,0))$ do not intersect each other. The left inequality follows from the estimate

$$\sum_{V \in \mathfrak{J}_{P_i}((0,1))} \text{area}(d(P_i)) \geq \frac{1}{2}(m_i^2 - s_i^2)$$

for each $i = 1, \dots, n$. Indeed, if P_i is not a vertex of H , then P_i belongs to an edge E_i .

If E_i is horizontal, then $s_i = 0$ and $\sum_{V \in \mathfrak{J}_{P_i}((0,1))} \text{area}(d(P_i)) \geq \frac{1}{2}m_i^2$ by Lemma 2.3.6. If E_i is not horizontal, then $s_i \geq m_i$ and the inequality becomes trivial. If P_i is a vertex of H , then the inequality follows from Lemma 2.3.6, because in this case

$$\sum_{V \in \mathfrak{J}_{P_i}((0,1))} \text{area}(d(P_i)) \geq (m_i - s_i) \cdot s_i + \frac{1}{2}(m_i - s_i)^2 = \frac{m_i^2 - s_i^2}{2}.$$

□

Proof of Theorem 1. By Corollary 2.2.16 there exists N such that there exists a generic with respect to Δ collection of points on the line $y = \frac{1}{\omega(\Delta)+1}$ with $|x_i|, |y_i| < N$. Then, Proposition 2.3.6 and Lemma 2.3.9 conclude the proof. □

Corollary 2.4.4. For the curves of degree d , the above corollary gives $d \geq (\sqrt{n} - \frac{1}{2} - \frac{1}{\sqrt{n}})m$ if $n \geq 4$.

Proof. Indeed, the Newton polygon of such a curve is the triangle

$$\text{ConvHull}(\{(0,0), (d,0), (0,d)\})$$

and its area is $\frac{d^2}{2}$. So, we have $d^2 \geq ((n - d/m - 1)m^2)$. If $d \geq m\sqrt{n}$, then we are done. Suppose that $d < m\sqrt{n}$, then $d^2 \geq (n - d/m - 1)m^2 \geq (n - \sqrt{n} - 1)m^2 \geq (\sqrt{n} - \frac{1}{2} - \frac{1}{\sqrt{n}})^2 m^2$ if $n \geq 4$. □

2.5 Speculations destined to code theory

In informatics, (error-correcting) *code-theory* deals with subsets $C \subset A^n$ (A is a finite set) which are as big as possible, and the Hamming distance d between the elements in C is also as big as possible, i.e. we maximize $\delta = \min_{a,b \in C, a \neq b} d(a,b)$. Such a subset C is called a *code* and it is suitable for the following problem. We transmit a message which is an element of C . If, during the transmission procedure, the message does change in at most $\frac{\delta}{2} - 1$ positions, then we can uniquely repara it back, that is why this is called an *error-correcting* code. As an introductory book, which relates this subject to algebraic geometry, see [158]. Studying of singular varieties is related with code-theory ([165]),

for the relation of this topic with Seshadri constants (which is a relative of Nagata's conjecture), see [73].

Finding such subsets C is a hard combinatorial problem. A particular source for codes is the set of linear subspaces of \mathbb{F}_q^n (*linear codes*), mostly because they have comparatively simple description. A common construction is the following. We chose points $p_1, p_2, \dots, p_n \subset \mathbb{F}_q^m$ and consider the set $V_d \subset \mathbb{F}_q[x_1, x_2, \dots, x_m]$ of the polynomials of degree no more than d (or we can take any linear system on a toric variety). Then we take the evaluation map: $ev_p : V_d \rightarrow \mathbb{F}_q^n$, $ev_p(f) = (f(p_1), f(p_2), \dots, f(p_n))$. The image of ev_p is a linear code, it is quite simple to calculate it, but the problem is how to chose points p_i such that there is no polynomials which vanish at chosen points (otherwise we need to deal with the kernel of ev_p) and how to estimate the minimal distance δ . For example, one may take all the points with all non-zero coordinates.

Thanks to Joaquim Roé suggestion, we mention here the way we can exploit the main ideas of this article to construct a linear code, which uses not too much points and provides a map, similar to ev_p , without kernel.

In the previous sections, for a given polygon Δ and numbers m_1, m_2, \dots, m_n we constructed the set of points $p_1, p_2, \dots, p_n \in \mathbb{F}_q$ such that there is no curve C with the Newton polygon Δ , possessing the property $\mu_{p_i}(C) \geq m_i$ for each i . Recall, that for this construction we should carefully chose points $(x_i, y_i) \in \mathbb{Z}^2$, then, for q big enough there is $t \in \mathbb{F}_q$, such that the points $p_i = (t^{x_i}, t^{y_i})$ possess the required properties.

Example 2.5.1. Consider $\Delta = [0, 1, \dots, d] \times [0, 1, \dots, N] \subset \mathbb{Z}^2$. If we put n points p_1, p_2, \dots, p_n of multiplicity $m \leq \min(N, d)$ along an almost horizontal line, then there is no algebraic curve C with the Newton polygon Δ and $\mu_{p_i}(C) \geq m$ if $dN < \frac{1}{2}(n - d/m - 1)m^2$.

Therefore, taking $N < \frac{(n-d/m-1)m^2}{2d}$ we construct the evaluation map $ev : \mathbb{F}_q^{dN} \rightarrow \mathbb{F}_q^{\frac{nm(m+1)}{2}}$ with a trivial kernel. For this map, we take a point $f \in \mathbb{F}_q^{dN}$, which we treat as a polynomial F with the Newton polygon Δ , then take the coefficients of $F \pmod{I_{p_i}^m}$ for each $i = 1, \dots, n$, this gives the image $ev(f)$.

Chapter 3

A guide to tropical modifications

**Substance is by nature prior to its modifications.
... nothing is granted in addition to the understanding,
except substance and its modifications.**

Ethics. Benedictus de Spinoza.

This chapter is dedicated to *tropical modifications*, which have already become a folklore in tropical geometry. Tropical modifications are used in tropical intersection theory and in study of singularities. They admit interpretations in various contexts such as hyperbolic geometry, Berkovich spaces, and non-standard analysis.

We cite [33]: “*Tropical modifications ... can be seen as a refinement of the tropicalization process, and allows one to recover some information ... sensitive to higher order terms.*”

One must say that the name “modification” is used in two different senses: the modification as a well-defined *operation*; and a modification along N as a *method* that reveals a behavior of other varieties in an infinitesimal neighborhood of N . Namely, performing the modification of M along $N \subset M$, we know how M changes, but the objects of codimension 1 in M may behave differently, depending on their behavior near N . We will clarify this distinction with examples.

Our main goal is to mention different points of view, give references, and demonstrate the abilities of tropical modifications. We assume that the reader have already met “tropical modifications” somewhere and wants to understand them better. There are novelties here: a tropical version of Weil’s reciprocity law is proven via tropical Menelaus Theorem and a new obstruction for realizability of non-transversal intersections is found. For a preliminary introduction to tropical geometry, see [29], [32] and [120], where tropical modifications are also discussed. We are glad to mention other texts, promoting modifications from different perspectives: [33] (examples, construction of curves with inflection points), [8] (repairing the j -invariant of elliptic curves), and [148] (intersection theory on tropical surfaces). The questions related to tropical singular points (see Chapter 1) are treated here from the perspective of tropical modifications, see Section 3.4.4.

We define tropical modifications via multivalued operations. Then we discuss several examples indicating principal features of the following observations. Then we obtain several structure theorems and list the set of applications. In Section 3.1 we summarize the interpretations of the tropical modifications, so a curious reader may start there and only after it return to Section 3.2.1.

3.1 Motivation and interpretations

*La science toujours progresse et jamais ne faillit,
 toujours se hausse et jamais ne dégénère,
 toujours dévoile et jamais n’occulte.
 Anonyme.*

This section contains ideas about why a tropical modification is a natural notion and several interpretations of a modification in different contexts. Since a big half of the material here represents some vague intuitions, it is not always possible to write precisely what is the analogy or metaphor means. Nevertheless, the blame for all misunderstanding is with me. The reader, interested in definitions, examples, and theorems, should directly proceed to the next section, and return here only for inspiration.

Tropical modifications were introduced in the seminal paper [116] as the main ingredient in the tropical equivalence relation. Namely, two tropical varieties are *equivalent* if they are related by a chain of tropical modifications and reverse operations¹.

The underlying idea is the following. Recall, that a tropical variety V can be decomposed into a disjoint union of a compact part V_c and a non-compact part V_∞ , and $V = V_c \cup V_\infty$. Moreover, V retracts on V_c . Then, the set V_∞ consists of “tree-like” unions of hyperplanes’ parts. We call these parts *legs* in the one-dimensional case and *leaves* in general situation. For tropical curves, V_∞ is a union of half-lines. For example, for a tropical elliptic curve (see Fig. 3.1, left side) the set V_c is the ellipse, and V_∞ is the set of trees growing on the ellipse.

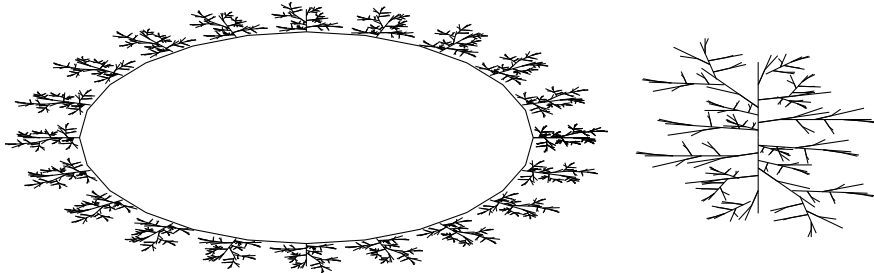

Figure 3.1: On the left side we see a tropical elliptic curve V which is a part of the analytification of an elliptic curve. The ellipse is V_c and the union of tree-like pieces is V_∞ . On the right side we see a tropical rational curve V , which is equal to V_∞ . We can chose each point of V as V_c , because V contracts onto any of its point $x \in V$.

Remark 3.1.1. On a tropical rational² variety V , each point may b chosen as V_c , see Fig. 3.1 right side. At the same time, there is a canonical way to define V_c for tropical varieties.

Definition 3.1.2. Let us define V_∞^1 as the set of points v of V such that the shortest path from v to “infinity” does not pass through the cells of the codimension one of the natural cell subdivision of V .

¹For the full definition of an abstract tropical variety, see [120] and [117].

²Basically, rational tropical varieties are the contractible ones. They are not well studied even in small dimensions. For example, there exist 3 dimensional cubic hypersurfaces which are not rational. It is not known whether we can see this tropically.

Then, let V_∞^2 be the set of points v of $V \setminus V_\infty^1$ such that the shortest path from v to “infinity” does not pass through the cells of the codimension one of the natural cell subdivision of $V \setminus V_\infty^2$. Then, for $n = 2, 3, \dots$ let V_∞^{n+1} be the set of points v of $V \setminus \bigcup_{i=1}^n V_\infty^i$ such that the shortest path from v to “infinity” does not pass through the cells of the codimension one of the natural cell subdivision of $\bigcup_{i=1}^n V_\infty^i$. Pick the minimal m such that $V = \bigcup_{i=1}^m V_\infty^i$. Then, $V_c = V_\infty^m, V_\infty = \bigcup_{i=1}^{m-1} V_\infty^i$.

Remark 3.1.3. In the case $V = V_\infty^1$ we should choose V_c as any point of V and $V_\infty = V \setminus V_c$.

Consider the tropical limit V of algebraic varieties $W_{t_i} \subset (\mathbb{C}^*)^n$, i.e. $V = \lim_{t_i \rightarrow \infty} \text{Log}_{t_i}(W_{t_i})$, where we apply the map $\text{Log}_{t_i} : \mathbb{C}^* \rightarrow \mathbb{R}, x \rightarrow \log_{t_i} |x|$ coordinate-wise. In this case the set V_∞ encodes the topological way of how W_i approach some compactification of $(\mathbb{C}^*)^n$. For the moment, the particular choice of the compactification does not matter³.

Besides, for i big enough, the Bergman fan $B(W_i) := \lim_{t \rightarrow \infty} \text{Log}_t(W_i)$ of W_i is equal to $\lim_{t \rightarrow \infty} \frac{1}{t} V$. The latter limit is obtained by contracting the compact part V_c of V , so the Bergman fan can be restored by V_∞ . Note, that V came here with a particular immersion to \mathbb{R}^n .

Example 3.1.4. If curves $W_i, i = 1, 2, \dots$ in $(\mathbb{C}^*)^2$ all have branches with asymptotic (s^k, s^l) with a local parameter $s \rightarrow \infty$, then the tropical limit V of this family lies in \mathbb{R}^2 , and V has the infinite leg (half-line) in the lattice direction (k, l) .

Let us suppose that we have an algebraic map $f : (\mathbb{C}^*)^n \rightarrow (\mathbb{C}^*)^m$, and f is in general position with respect to the family $\{W_i\}$, i.e. for each i big enough, the image $f(W_i)$ is birationally equivalent to W_i . Let V' be the tropical limit of the family $\{f(W_i)\}$. One can prove that V'_∞ differs from V_∞ by adding new half-planes and contracting other half-planes, look into Section 1.7 for examples. These half-planes grow along the tropicalization of zeros and poles of f on W_i . This consideration suggests the ideas of *modification* and *tropical birational equivalence*. The name “modification” was borrowed from complex analysis, and tropical modification is sometimes called “tropical blow-up”.

In Section 3.4.2 we see how the notion of modifications allows us to define the *category of tropical curves*. This category keeps track of birational isomorphism in the category of complex algebraic curves. See also §3.3.1, where making modifications for curves simplifies a proof to some extent.

Tropical geometry can be also thought as studying of skeletons of analytifications of algebraic varieties. We can obtain a tropical variety V as the non-Archimedean amoeba of an algebraic variety W over a non-Archimedean field. This approach (see section §3.1.2) finally suggests the same idea of equivalence up to modification, because the analytification W^{an} is the injective limit of all “affine” tropical modifications (i.e. along only principal divisors) of V (see [134]). Berkovich proved that W^{an} retracts on a finite polyhedral complex, so V_0 is a deformation retract of W^{an} . Even better, the metric on W^{an} agrees with the metric on V for the case of curves⁴ ([13]).

Connection between tropical geometry and analytic geometry leads to the questions of *lifting or realizability*, i.e. what could be the intersection of two varieties X, Y if we know the intersection of their tropicalizations? In fact, if their tropicalizations $\text{Trop}(X), \text{Trop}(Y)$ intersect transversally, the answer is relatively simple, see [127]. If the intersection of $\text{Trop}(X), \text{Trop}(Y)$ is non-transverse, then we can lift *the stable intersection* of these tropical varieties, see [128],[138].

³For a fixed compactification, see the notion of sedentarity in [150] and [29], p. 44.

⁴That should be true for varieties of any dimension, modulo integer affine transformations, but no proof has appeared yet. For the skeletons in higher dimensions see [67, 68].

This raised the following question: to what extent the only condition for a divisor on a curve to be realizable as an intersection is to be rationally equivalent to the stable intersection (cf. [122], Conjecture 3.4)?

Tropical modification (as a *method*) helps dealing with such questions. It is known that being rationally equivalent to the stable intersection is not enough. We consider other existing obstructions (in fact, equivalent to Vieta theorem) for what can happen in non-transverse tropical intersections, and prove, for that occasion, the tropical Weil reciprocity law by using the tropical momentum.

Consequently, modifications are used in tropical intersection theory ([148, 149]), to define the intersection product. Nevertheless, one must use modifications along non-Cartier divisors (Examples 1.1.37, 3.4.18 in [149], for moduli space of five points on rational curve) and even along non-realizable subvarieties – for a proof that they are non-realizable as tropical limits.

As we stated before, one should think that a tropical modification along X reveals asymptotical behavior of objects near X . We can find an analogy in non-standard analysis: the tropical line is the hyperreal line, the modification at a point is an approaching this point with *an infinitesimal telescope*, see Fig. 3.3 and Section 3.1.2. In order to define tropical Hopf manifolds one should also use the modifications to study their germs [145].

Given a surface with hyperbolic structure, we can make a puncture at x . This changes the hyperbolic structure and x goes, in a sense, to “infinity”. A tropical curve can be obtained as a degeneration of hyperbolic structures, and making a puncture at x results as the modification at the limit of x , see Section §3.1.1.

A modification can be described as a graph of a function, if we use the convention about multi-valued addition, brought in tropical geometry by Oleg Viro ([163]), see the next section.

The other applications of tropical modification as a *method* are following. Passing to tropical limit squashes a variety, and some local features become invisible. In order to reveal them back we can do a modification⁵. For example, modifications allow us to restore transversality between lines if we have lost it during tropicalization (§3.4.3), then it allows us to see (-1)-curves on del Pezzo surfaces ([140]). Methods of lifting non-transverse intersections leads us to use modifications in questions about singularities: inflection points – [33], singular points – [106]. As an example, we use modification in the study of singular points of order m (but obtain weaker results than in [81]).

3.1.1 Hyperbolic approach and moduli spaces

Consider a tropical curve C given as the limit of complex curves C_i . From the point of view of hyperbolic geometry, a modification at a point x of tropical curve C means just making a puncture x_i in C_i , with condition that $x_i \rightarrow x$. To explain this we need to know how to directly construct tropical curves via limits of abstract surfaces with hyperbolic structure on them, without any immersions⁶.

So, for details how tropical geometry can be built on on the ground of hyperbolic geometry, see [96]. Here we briefly sketch the construction.

The approach, proposed by L. Lang, uses the collar lemma ([36]). This lemma simply says that any closed geodesic of length l has a collar of width $\log \coth(l/4)$ and what is more important, for

⁵so the metaphor “look in an infinitesimal microscope” grasps the essence.

⁶Usually people consider curves C_i in toric variety X and then they consider degeneration of complex structures on X .

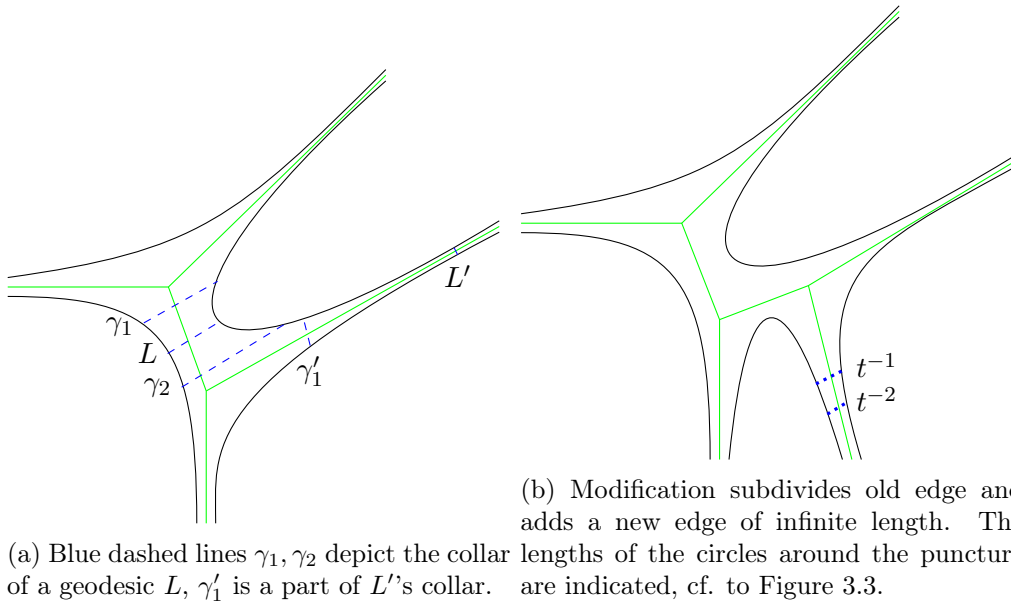

Figure 3.2: We draw the limits of hyperbolic surfaces, i.e. tropical curves. Modification adds a puncture to each curve in the family and a leg to the tropical curve.

different closed geodesics their collars do not intersect, see Fig. 3.2. That is also important that smaller geodesics have bigger collars (and, intuitively, a puncture has the collar if infinite width).

Thus, given a family of curves C_i (of the same genus), we consider a fixed pair-of-pants decomposition by geodesics L_i . The tropical curve is constructed as follows: its vertices are in one-to-one correspondence with the pair-of-pants, each shared boundary component between two pairs-of-pants correspond to an edge of the tropical curve, and the collar lemma furnishes us with the length of the edges of the tropical curve as the logarithms (with base t , and $t \rightarrow \infty$ as the hyperbolic structure degenerates) of widths of the collars of L_i 's. Compare this approach with [26].

What will happen if we make a puncture? A puncture is the limit of small geodesic circles. Cutting out a disk with radius t^l add a leaf of finite length, as it is seen from the above description. Therefore, cutting out a point results in adding an infinite edge, i.e. a modification.

That explains why a permanent using of graphs for moduli space problems actually work ([94], then compare with tropical interpretation [85]). Tropical curves describe the part of boundary of a moduli space, and modification corresponds to marking a point (read [53] to see the hyperbolic view on moduli space problems), which are punctures from the hyperbolic point of view (see applications to moduli space of points [117]). Tropical differential forms are also defined in this manner while taking a limit of hyperbolic structure [120].

3.1.2 Berkovich spaces, non-standard analysis

Non-standard analysis appeared as an attempt to formalize the notion of “infinitesimally small” variables (see §4 of [155] for a nice and short exposition).

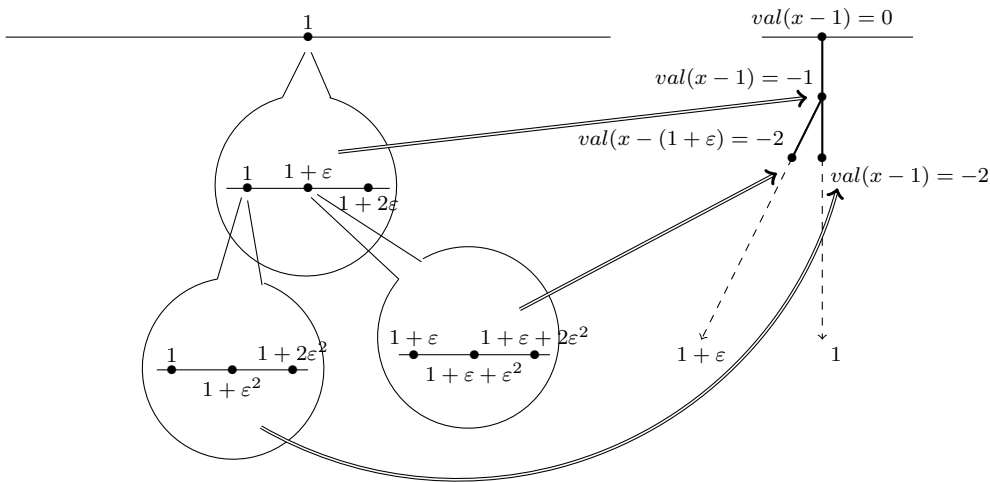

Figure 3.3: Similarity in the pictures of infinitesimal microscope (left) and tropical modification at points 1 and $1 + \varepsilon$ (right).

There is an approach to tropical geometry via nonstandard analysis (cf. §1.4 [78]) and the following Fig. 3.3 shows that tropical modifications is similar to “infinitesimal microscope” for the hyperreal line in the terminology of [84], and this interpretation in computational sense is the same as for Berkovich spaces: doing modification at the point $x = 1$ on a curve is adding a leg to the tropical curve, which ranges points according to their asymptotical distance to $x = 1$, i.e. $\text{val}(x - 1)$, these pictures are also similar to the hyperbolic ones (Figure 3.2).

It is worth noting that there are still no applications of this point of view, neither in tropical geometry, nor in non-standard analysis. Still, Berkovich spaces can be treated as a more modern version of non-standard analysis, and tropical modification has applications there.

We should say that an important feature of tropical geometry is that it erects a bridge from a very geometric things (hyperbolic geometry) to very discrete things as p -adic valuations and non-Archimedean analysis.

See Figure 3.1, the analytification of an elliptic curve on the left, the analytification of \mathbb{P}^1 on the right. Ends of leaves represent the norms with “zero” radius; . Berkovich spaces appeared as a wish to have an analytic geometry on discrete spaces. The analytification X^{an} of a variety X is the set of all seminorms on functions on X . Each point $x \in X$ defines such a seminorm by measuring the order of vanishing of a function at x , on Figure 3.1 these points are represented by the ends of leaves. For the sake of shortness, we refer the reader to a nice introduction in Berkovich spaces, with a bit of pictures [12],[156] and to [13] to see how it has been applied to tropical geometry (also, see on the page 7 in [13], using of log reminds hyperbolic approach). Also there exists Berkovich skeletons of analytifications, they correspond to the compact part V_c of a tropical variety, for example, for elliptic curves that will be a circle in both tropical and analytical cases, and its length is prescribed by j -invariant of a curve ([8]). The analytification of an elliptic curve is the injective limit of all modifications of its tropicalization, see Figure 3.1.

3.2 Definitions and examples

3.2.1 Definition: tropical modification via the graphs of functions

Recall that the tropical semi-ring \mathbb{T} is defined as $\mathbb{T} = \mathbb{R} \cup \{-\infty\}$, with the operation addition (“+”) and order as for the real numbers, we extend addition by the rule $-\infty + A = -\infty$ for all $A \in \mathbb{T}$, and the order by the rule $-\infty < A$ for all $A \in \mathbb{R}$. The fastest way to define the tropical modifications is via multivalued tropical addition.

Definition 3.2.1. [163]. Define tropical addition $+_{\text{trop}}$ and multiplication \cdot_{trop} on the set \mathbb{T} as follows:

- $A \cdot_{\text{trop}} B = A + B$,
- $A +_{\text{trop}} B = \max(A, B)$ if $A \neq B$, and
- $A +_{\text{trop}} A = \{x | x \leq A\}$.

We can say, equivalently, that the operation \max is redefined to be multivalued in the case of equal arguments, i.e. $\max(A, A) = \{X | X \leq A\}$.

Remark 3.2.2. We extend this operations on the sets in the standard way. Also, note that all the sets we can obtain are of the type $\{X | X \leq A\}$ for some $A \in \mathbb{T}$.

Definition 3.2.3. A tropical monomial is a function $f : \mathbb{T}^n \rightarrow \mathbb{T}$,

$$f(X_1, X_2, \dots, X_n) = A + i_1 X_1 + i_2 X_2 + \dots + i_n X_n, \text{ where } A \in \mathbb{T}, (i_1, i_2, \dots, i_n) \in \mathbb{Z}^n. \quad (3.1)$$

A tropical polynomial is a **tropical** sum (i.e. we use the operation $+_{\text{trop}}$) of a finite number of tropical monomials. A point $X' = (X_1, X_2, \dots, X_n)$ belongs to the zero set of a tropical polynomial f if $0 \in f(X')$. A tropical hypersurface (as a set) is the zero set of a tropical polynomial on \mathbb{T}^n .

Remark 3.2.4. In order to have the balancing condition satisfied, one has to provide a tropical hypersurface with weights on its faces of the maximal dimension. We assume that the reader understands how to do it. We also suppose that the reader knows the definition of an abstract tropical variety, if it is not the case, refer to [119].

Definition 3.2.5. Let N be a tropical hypersurface in $M = \mathbb{T}^n$, let f be a tropical polynomial on \mathbb{T}^n and N be the zero set of f . The modification of \mathbb{T}^n along N is the set

$$m_N(\mathbb{T}^n) = \{(X, Y) \in \mathbb{T}^n \times \mathbb{T} | Y \in f(X)\}, \quad (3.2)$$

i.e. the graph of the multivalued function f . For a given tropical variety $K \subset M$, a tropical subvariety $m_N(K) \subset m_N(\mathbb{T}^n)$ is called a modification of K if the natural projection $p : \mathbb{T}^n \times \mathbb{T} \rightarrow \mathbb{T}^n$ restricted to $m_N(K)$ is a tropical morphism $p : m_N(K) \rightarrow K$ of degree one.

Proposition 3.2.6 ([119], 1.5 B,C). The set $m_N(\mathbb{T}^n)$ coincides with the zero set of the polynomial $f(X) +_{\text{trop}} Y : \mathbb{T}^n \times \mathbb{T} \rightarrow \mathbb{T}$.

Definition 3.2.7. For an abstract tropical variety M and its subvariety $N \subset M$ defined as the zero set of a tropical function $f : M \rightarrow \mathbb{T}$, we define the tropical modification $m_N(M)$ of M along N as the graph of f in $M \times \mathbb{T}$. A subvariety $m_N(K) \subset m_N(M)$ is called a modification of K along N if the natural projection $m_N(K) \rightarrow K$ is a tropical morphism of degree one.

Now we explain how the given definitions appear through limiting procedures. Consider two algebraic curves $C_1, C_2 \subset (\mathbb{C}^*)^2$ defined by equations $F_1(x, y) = 0, F_2(x, y) = 0$, respectively. We build the map $m_{C_2} : (x, y) \rightarrow (x, y, F_2(x, y)) \in (\mathbb{C}^*)^3$. The set $m_{C_2}((\mathbb{C}^*)^2)$ is the graph of F_2 , $z = F_2(x, y)$. Now the intersection $C_1 \cap C_2$ can be easily recovered as $m_{C_2}(C_1) \cap \{(x, y, 0)\}$. For the complex curves this seems to be not very interesting, but during the tropicalization process the plane $(x, y, 0)$ goes to the plane $(X, Y, -\infty) = \{Z = -\infty\}$, and the intersection of tropical curves will be represented by certain rays going to minus infinity by Z coordinate.

We look now on the limiting procedure. Given two tropical curves $C_1, C_2 \subset \mathbb{T}^2$, we start with $C_{1,t}, C_{2,t}$ – two families of plane algebraic curves, which tropicalize to C_1, C_2 , i.e., in the Gromov-Hausdorff sense we have

$$C_1 = \lim_{t \rightarrow \infty} \text{Log}_t(C_{1,t}), C_2 = \lim_{t \rightarrow \infty} \text{Log}_t(C_{2,t}),$$

where we apply $\text{Log}_t : \mathbb{C} \rightarrow \mathbb{T}$ coordinate-wise, i.e. $\text{Log}_t(C_1) = \{(\log_t |x|, \log_t |y|) | (x, y) \in C_1\}$. Let $F_{2,t}$ be the equation of $C_{2,t}$.

Proposition 3.2.8. The tropical modification $m_{C_2} \mathbb{T}^2$ of \mathbb{T}^2 along C_2 is the limit of surfaces $S_t = \text{Log}_t\{(x, y, F_{2,t}(x, y)) \in \mathbb{C}^3 | (x, y) \in \mathbb{C}^*\}$, i.e. $m_{C_2} \mathbb{T}^2 = \lim_{t \rightarrow \infty} S_t$.

Proposition 3.2.9. The tropical limit of the curves $m_{C_{2,t}}(C_{1,t}) \subset m_{C_{2,t}}((\mathbb{C}^*)^2)$, i.e. $m_{C_2} C_1 = \lim_{t \rightarrow \infty} \text{Log}_t m_{C_{2,t}}(C_{1,t})$, is a tropical modification $m_{C_2} C_1$ of C_1 .

Even though the families $C_{1,t}, C_{2,t}$ are included in the data, the graph $m_{C_2} \mathbb{T}^2$ does not depend on this choice. However, for given tropical curves C_1, C_2 we can construct different families $C_{1,t}, C_{2,t}$ and the limit $\lim_{t \rightarrow \infty} \text{Log}_t m_{C_{2,t}}(C_{1,t})$ can be different.

Note that we always suppose that an algebraic hypersurface comes with a defining equation. Also, instead of taking the limit we can consider non-Archimedean amoebas of the varieties defined over valuation fields.

Definition 3.2.10. Let $M' \subset (\mathbb{K}^*)^n$ be a variety over a valuation field \mathbb{K} . Let $N' \subset (\mathbb{K}^*)^n$ be an algebraic hypersurface defined by an equation $f(x) = 0, x \in (\mathbb{K}^*)^n$. The modification $m_{N'}(M')$ is the set $\{(x, f(x) | x \in (\mathbb{K}^*)^n)\} \subset (\mathbb{K}^*)^{n+1}$. The modification of $M = \text{Trop}(M')$ along $N = \text{Trop}(N')$ is the non-Archimedean amoeba of the set $\{(x, f(x) | x \in V\} \subset (\mathbb{K}^*)^{n+1}$.

In general, **למושה תורה** and [76] all the approaches are equivalent.

Proposition 3.2.11. Consider a tropical variety $M \subset \mathbb{T}^n$ and a tropical hypersurface N defined by a tropical polynomial F . Then, three following objects coincide:

- the tropical modification $m_N(M)$ of M along N defined via multivalued operations.
- the limit $\lim_{t \rightarrow \infty} \log_t(\{x, F_t(x) | x \in \mathbb{C}^n\})$ where $M = \lim_{t \rightarrow \infty} \log_t(M_t), N = \lim_{t \rightarrow \infty} \log_t(N_t)$, $M_t, N_t \in \mathbb{C}^n$ and N_t is defined by a polynomial F_t ,

- $\text{Trop}(G_F(M'))$ where $M', N' \in \mathbb{K}^n$, \mathbb{K} is a valuation field, $\text{Trop}(M') = M$, $\text{Trop}(N') = N$, N' is given by a polynomial F , and $G_F(M) = \{(x, F(x)) | x \in M\} \subset \mathbb{K}^{n+1}$ is the graph of F on the variety M .

Note that given **only** tropical curves $C_1, C_2 \subset \mathbb{T}^2$ it is often not possible to uniquely “determine” the image of C_1 after the modification along C_2 . That is why a modification of a curve along another curve is rather *a method*. The strategy is the following: given two tropical curves, we lift them in a non-Archimedean field (or present them as limits of complex curves, that is the same), then we construct the graph of the function as above and tropicalize the result. Depending on the conditions we imposed on lifted curves (be smooth or singular, be tangent to each other, etc), we will have a set of possible results for modification of one curve along the second, see examples below.

Still, we know the sum of the coordinates of all the legs of $m_{C_2}(C_1)$ going to minus infinity by Z -coordinate, see Proposition 3.3.20.

3.2.2 Examples.

In this section we calculate examples of the modification, treated as a method. You should not be scared with these horrific equations, they are reverse-engineered, starting from the pictures. All the calculations are quite straightforward.

We start by considering the modification along itself and discuss an appearing ambiguity in this case. Then, we consider how modifications resolve indeterminacy that happens when the intersection of tropical objects is non-transversal. Also this example promotes the point of view that a tropical modification is the same as adding a new coordinate.

In the third example a modification helps to recover the position of the inflection point. Also, the usefulness of the tropical momentum and tropical Menelaus Theorem is demonstrated. The tropical Weil theorem which shortens the combinatorial descriptions of possible results of a modification is proved in Section 3.3.1.

In the fourth example we study the influence of a singular point on the Newton polygon of a curve. The same method suits for higher dimension and different types of singularities, but nothing is yet done there, due to complicated combinatorics. In the same example we describe how to find all possible valuations of the intersections of a line with a curve, knowing only their stable tropical intersection – the answer is Vieta theorem. The same arguments may be applied for non-transversal intersections of tropical varieties of any dimension.

Example 3.2.12. Modification along itself

Consider a tropical horizontal line L , given by $\max(1, Y)$. This is the tropicalization of a line like $y = t^{-1} + o(t^{-1})$. Note that if we make a modification of a line along itself, then all its points go to the minus infinity (Figure 3.4, left). Indeed, if $F(x, y)$ is the equation of C , then the set of points $\{(x, y, F(x, y)) | (x, y) \in C\}$ belongs to the plane $z = 0$, so $\text{Val}(\{(x, y, F(x, y)) | (x, y) \in C\}) \subset \{(X, Y, Z) \in TT^3 | Z = -\infty\}$. On the other hand, if we consider two different lines C_1, C_2 (with equations $y = t^{-1}$ and $y = t^{-1} + t^3$) with tropicalization L , then all the points in $m_{C_1}C_2$ have the valuation -3 of Z coordinate. Again, we see an ambiguity – even if L is fixed, we can take different lifts of L and have different results of the modification. On the other hand we can say that the canonical modification along itself is the result similar to Figure 3.4, left, i.e. we require that $m_C C$ is the projection of C to the plane $Z = -\infty$.

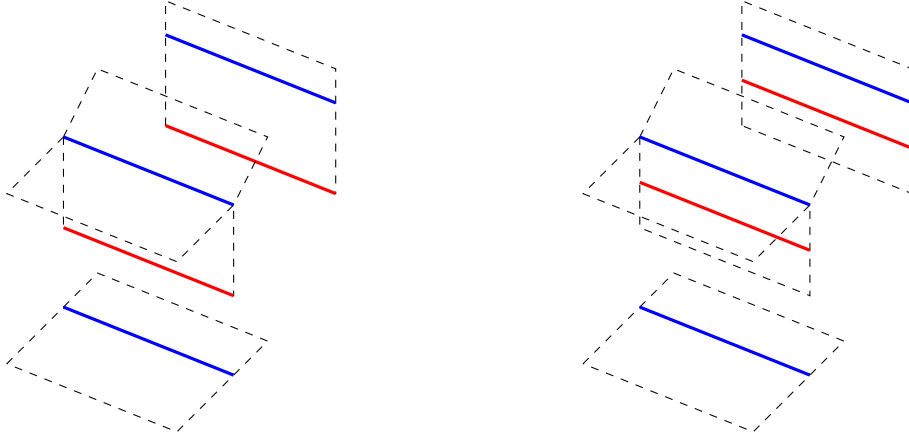

Figure 3.4: Example of a modification of a line along itself. Let L_1, L_2 be defined by $y = t^{-1}, y = t^{-1} + t^3$ respectively. On the left we see the modification of L_1 along L_1 , on the right we see the modification of L_2 along L_1 . Red line if the result of the modification.

Example 3.2.13. Modification, root of big multiplicity, Figure 3.5a.

In this example we see two tropical curves with non-transverse intersection which hides tangency and genus. Consider the plane curve C , given by the following equation: $F(x, y) = 0$,

$$F(x, y) = (x - t^{1/3})^3(x - t^{-2}) + t^{-4}xy^2 + (t^{-4} + 2t^{-5})xy + (t^{-5} + t^{-6})x.$$

Its tropicalization⁷ is the curve, given by the set of non-smooth points of

$$\text{Trop}(F) = \max(1, 6 + x, 5 + x + y, 4 + x + 2y, 5/3 + 2x, 2 + 3x, 4x).$$

We want to know what is the intersection of C with the line L given by the equation $y + t^{-1} = 0$. Tropicalizations of C and L are drawn on Figure 3.5a, below, as well as the Newton polygon of C . The intersection is not transverse, hence we do not know the tropicalization of $C \cap L$.

Then, let us consider the map $m_L : (x, y) \rightarrow (x, y, y + t^{-1})$. On Figure 3.5a, in the middle, we see the tropicalization of the set $\{(x, y, y + t^{-1})\}$ and the tropicalization of the image of C under the map m_L . Let $G(x, z)$ be the equation of the projection of $m_L(C)$ on the xz -plane. So, $F(x, y) = 0$ implies that for the new coordinate $z = y + t^{-1}$ we have

$$G(x, z) = 0, G(x, z) = (x - t^{1/3})^3(x - t^{-2}) + t^{-4}xz + t^{-4}xz^2. \quad (3.3)$$

Therefore the curve $C' = pr_{xz}m_L(C)$ is given by the set of non-smooth points of $\max(1, 4 + X + Y, 4 + X + 2Y, 2 + 3X, 4X)$, we see C' on the projection onto the plane XZ on the left part of Figure 3.5a. One can notice, that in order to have transversal intersection of non-Archimedean amoebas we did nothing else as a change of coordinates.

⁷One can think that we have a family of curves C_t with parameter t and its tropicalization is the limit of amoebas $\lim_{t \rightarrow 0} \text{Log}_t(\{(x, y) | F(x, y) = 0\})$, or that we have a curve C over Puiseux series $\mathbb{C}\{\{t\}\} = \mathbb{K}$ given by $\sum a_{ij}x^i y^j = 0, a_{ij} \in \mathbb{K}$. Its non-Archimedean amoeba is given by the set of non-smooth points of the function $\max_{ij}(\text{val}(a_{ij}) + ix + jy)$. Both ways lead to the same result.

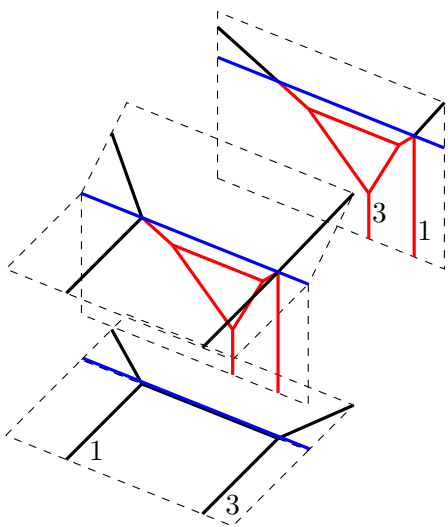

(a) Initial picture is below. In the center we see the limit of the graphs of the functions $F_{2,t}$. On the picture behind we see the projection of the graph to the plane XZ . Numbers on the edges are the corresponding weights.

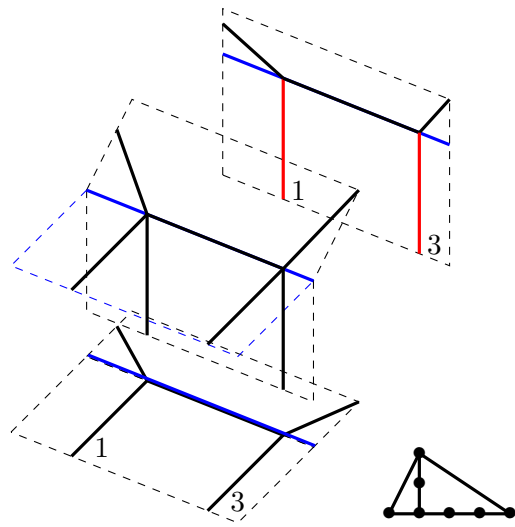

(b) Notation is the same as for the picture on the left. We see the result of the modification in the case when the stable intersection is the actual intersection. The Newton polygon of the curve C is depicted below.

Figure 3.5: Example of a modification along a line

Remark 3.2.14. Consider the restriction of $\text{Trop}(F)$ on the line $Y = 1$. We obtain $\max(1, 7 + X, 5/3 + 2X, 2 + 3X, 4X) = \max(1, 7 + X, 4X)$ which corresponds to the stable intersection. On the other hand, if we restrict F on the line $y + t^{-1} = 0$ and only then take the valuation, we obtain $\max(1, 3X + 2, 4X)$ because $F(x, -t^{-1}) = (x - t^{1/3})^3(x - t^{-2})$, and we see that this agrees with the picture of the modifications.

Definition 3.2.15. As we see in this example, a tropical curve in \mathbb{T}^n typically contains infinite edges. We call them *legs* of a tropical curve. For each leg we have a canonical parametrization $(a_0 + p_0s, a_1 + p_1s, a_2 + p_2s)$ where $a_i \in \mathbb{R}, p_i \in \mathbb{Z}, s \in \mathbb{R}, s \geq 0$, where the vector (p_0, p_1, p_2) , the *direction* of the leg, is primitive.

Now, on the tropicalization of C' we see a vertical leg of weight 3, i.e. z coordinate is zero at this point. That happens because we have the tangency of order 3 between C and L , and z as a function of x has a root of order 3.

Note that this leg can not mean the point is a singular point of C , because the curve C (according to criteria of [106] or, more generally [81]) has no singular points, even though the tropicalization of C has an edge of multiplicity 3.

Thus, this new tropicalization restores the valuations of intersection. We see that the modification of the plane (i.e. amoeba of the set $\{(x, y, y + t^{-1})\}$) is defined, but in codimension one this procedure shows order of roots and more unapparent structures like hidden genus. One can think that this cycle was close to intersection, but after change of coordinates it becomes visible on the picture of the amoeba of C' .

Remark 3.2.16. Nevertheless, for a general choice of representative in Puiseux series for these two tropical curves $\text{Trop}(C), \text{Trop}(L)$, after modification we will have Fig. 3.5b, which represents stable intersection of the curves.

Example 3.2.17 (Modification, inflection point, momentum map). We consider a curve and its tangent line at an inflection point. Suppose, that the intersection of their tropicalizations is not transverse. How can we recover the presence of the inflection point?

We consider a curve C with the equation $F(x, y) = 0$ where

$$F(x, y) = y + t^{-3}xy + (t^{-1} + 4 + 6t + 4t^2 + t^3)x^2 + (-t^{-3} - 3 - t - t^2)xy^2 + (t^{-2} - t^{-1} - 2 + t^2 + t^3)x^2y + x^2y^2,$$

and a line L with the equation $y = 1 + tx$. The equation of the curve is chosen just in such a way that the restriction of F on the line L is $t^2(x - 1)^3(x - t^{-1})$, i.e. the point $(1, 1 + t)$ is the inflection point of the curve and L is tangent to C at this point.

Tropicalization of the curve is given by the following equation:

$$\text{Trop}(F) = \max(y, x + y + 3, 2x + 1, 2x + y + 2, x + 2y + 3, 2x + 2y). \quad (3.4)$$

On the Fig. 3.6a we see the non-Archimedean amoeba of the image of the curve under the map $(x, y) \rightarrow (x, y, y - 1 - tx)$.

In order to find X -coordinates of the possible legs we can apply the tropical momentum: see Figure 3.3.2.

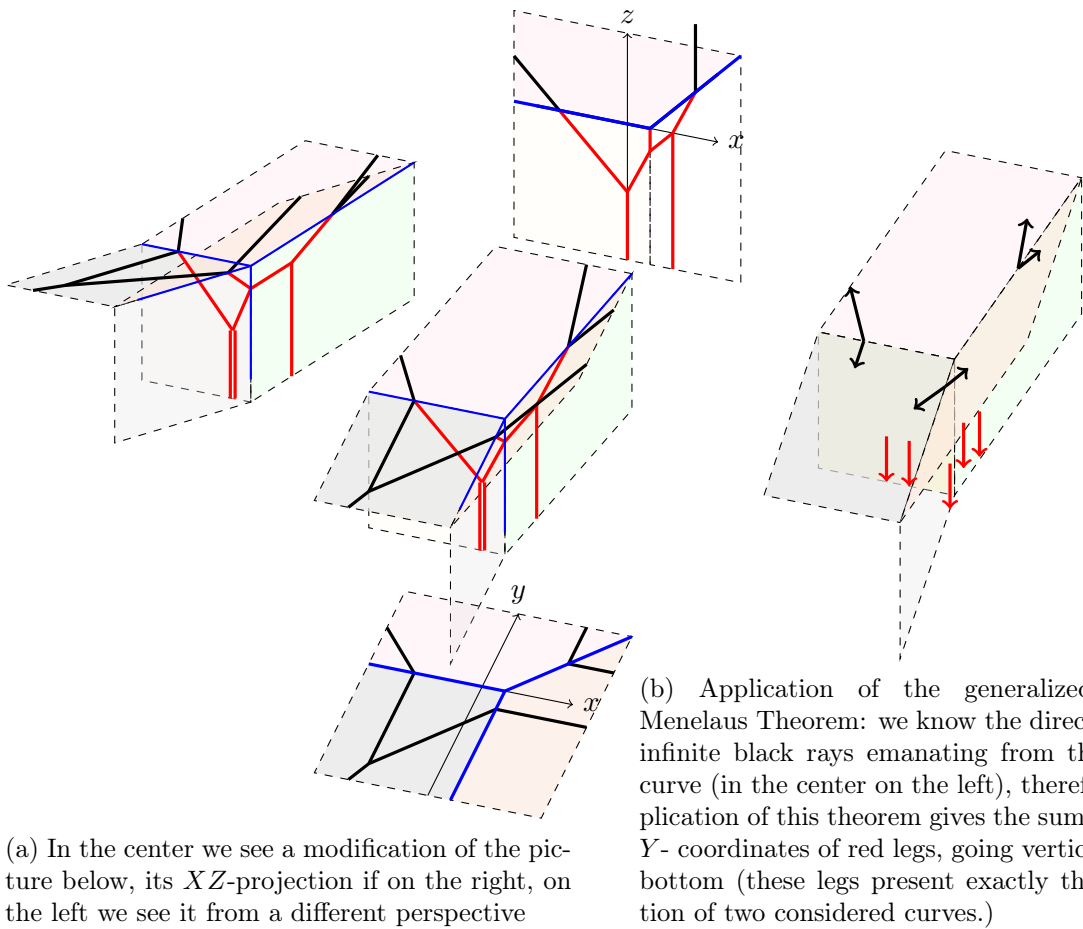

Figure 3.6: Example of modification in the case of inflection point. The point $(0, 0)$ on the bottom picture is the tropicalization of the inflection point. We modified the black curve along the blue curve, red parts are the parts becoming visible after the modification.

Definition 3.2.18. The momentum of a leg $(A_0 + P_0s, A_1 + P_1s, A_2 + P_2s)$ with respect to a point (B_0, B_1, B_2) is the vector product $(A_0 - B_0, A_1 - B_1, A_2 - B_2) \times (P_0, P_1, P_2)$.

We will prove a (simple) theorem that the sum of the moments of the legs, counted with their weights, is zero. Note, that in our case, all the legs we do not know are of the form $(X_0, Y_0, Z_0 - s)$, because they are vertical. Refer to Figure 3.6b. So, we take the vertex O of the tropical plane, and sum up the vector products $OX_i \times X_iY_i$ where X_iY_i are black legs (that we already know) and red legs (which are all vertical). Computation gives us $(-4, 0, 0) \times (-1, 1, 1) + (-4, 0, 0) \times (0, -1, 0) + (0, -1, 0) \times (-1, -1, 0) + (0, -1, 0) \times (1, 0, 1) + (2, 2, 2) \times (1, 0, 1) + (2, 2, 2) \times (0, 1, 1) + (X, 0, 0) \times (0, 0, -1) + (0, Y, 0) \times (0, 0, -1) + (Z + 1, Z, 0) \times (0, 0, -1) = 0$, i.e. $(1, -2, 0) + (Y + Z + 1, X + Z, 0) = 0$, where X stands for the sum of the X -coordinates of the vertical legs situated under the line $(1 - s, 0, 0)$, Y stands for the sum of the Y -coordinates of the vertical legs under the line $(1, -s, 0)$, Z stands for the sum of the Y -coordinates of the vertical legs under the line $(1, s, s)$.

On the left picture we see where the red legs are situated. But, since modification of a tropical curve C along a tropical curve C' is not canonically defined⁸, then, for example, a modification of C could differ from C just by adding vertical legs at four vertices of the C : this would correspond to stable intersection (which is always realizable in the sense that there exist curve in Puiseux series, such that, etc.)

Example 3.2.19. Singular point, its unique position, and possible liftings of intersection Consider a curve C' defined by the equation $G(x, y) = 0$, where

$$G(x, y) = t^{-3}xy^3 - (3t^{-3} + t^{-2})xy^2 + (3t^{-3} + 2t^{-2} - 2t^{-1})xy - (t^{-3} + t^{-2} - 2t^{-1} - 3t^2)x + t^{-2}x^2y^2 - (2t^{-2} - t^{-1})x^2y + (t^{-2} - t^{-1} - 3t^2)x^2 + t^{-1}y - (t^{-1} + t^2) + t^2x^3.$$

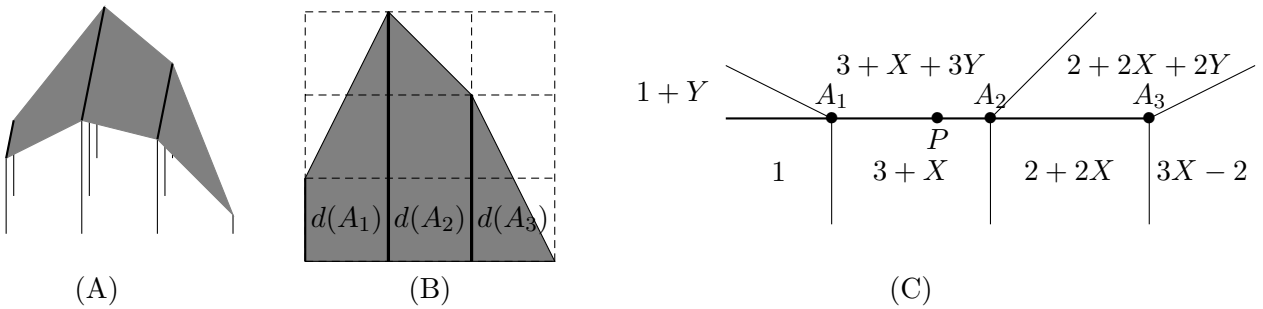

Figure 3.7: The extended Newton polyhedron $\tilde{\mathcal{A}}$ of the curve C' is drawn in (A). The projection of its faces gives us the subdivision of the Newton polygon of C' ; see (B). The tropical curve $\text{Trop}(C')$ is drawn in (C). The vertices A_1, A_2, A_3 have coordinates $(-2, 0), (1, 0), (4, 0)$. The edge A_1A_2 has weight 3, while the edge A_2A_3 has weight 2. The point P is $(0, 0) = \text{Val}((1, 1))$.

⁸If the intersection $C \cap C'$ is transverse, then the modification is uniquely defined.

Let us make the modification along the line $y = 1$. For that we draw the graph of the function $z(x, y) = y - 1$.

Note that we can easily find the number (with multiplicities) of the vertical legs. Indeed, each edge from A_1, A_2, A_3 going up in direction (i, j) becomes after the modification a ray going in the direction (i, j, j) , therefore, the total momentum of the vertical legs is the sum of Y -parts of momenta of the edges going up from A_1, A_2, A_3 , that is, 3. Then, if we know that after the modification our curve has a leg of multiplicity 3, then its unique position can be found from the generalized tropical Menelaus theorem.

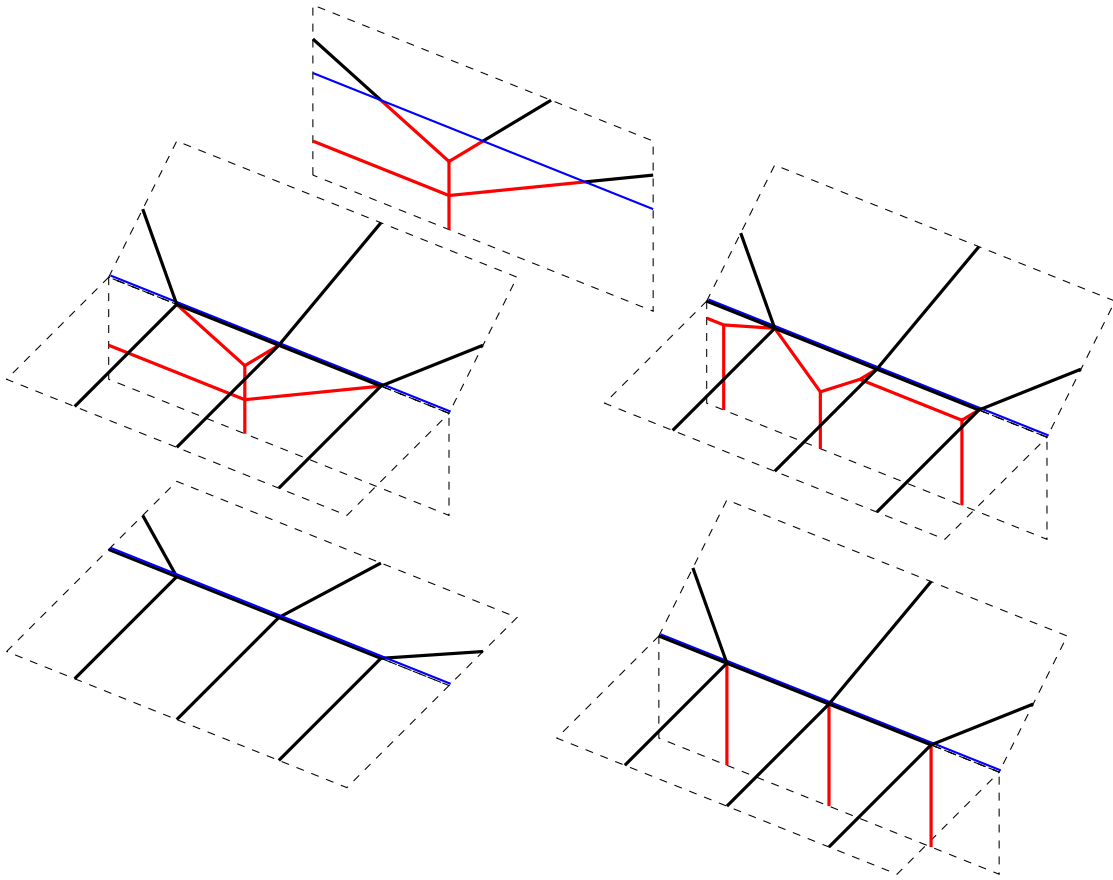

Figure 3.8: Refer to Example 3.2.19

3.3 Some structural theorems about tropical modification

Proposition 3.3.1. Suppose that a horizontal edge E contains a point P . Suppose that on the dual subdivision of the Newton polygon the vertical edge $d(E)$ is dual to E . Let the endpoints of E be A_1, A_2 and two faces $d(A_1), d(A_2)$ adjacent to $d(E)$ have no other vertical edges. Let the sum of widths in the horizontal direction of the faces $d(A_1), d(A_2)$ equals to m . Then the stable intersection of E with a horizontal line through E is m .

Proof. Refer to Example 3.2.19 and Figure 3.5b. Let L be a tropical line containing E and with vertex not coinciding with the endpoints of E . Making the modification along the line l we see that the sum S of vertical components of edges going upward from A_1, A_2 equals the sum m of the y -components of them.

Then, the sum of vertical components of edges, going downwards, equals S by the balancing condition for tropical curves. Sum of y -components of edges in the vertex v is exactly the width in the $(1, 0)$ direction of the dual to v face $d(v)$ in the Newton polygon. \square

Here we repeat some definitions from Section 1.7 (see also [81]).

The *multiplicity* $m(P)$ of the point P of the intersection of two lines in directions $u, v \in P(\mathbb{Z}^2)$ is $|u_1 v_2 - u_2 v_1|$ where $u \sim (u_1, u_2), v \sim (v_1, v_2)$ (Def. 1.2.24).

Given two tropical curves $A, B \subset \mathbb{T}^2$ we define their *stable intersection* as follows. Let us choose a generic vector v . Then we consider the curves $T_{tv}A$ where $t \in \mathbb{R}, t \rightarrow 0$ and T_{tv} is translation by the vector tv . For a generic small positive t , the intersection $T_{tv}A \cap B$ is transversal and consists of points $P_i^t, i = 1, \dots, k$ with multiplicities $m(P_i^t)$.

Definition 3.3.2 (cf. [142]). For each connected component X of $A \cap B$, we define *the local stable intersection of A and B along X* as $A \cdot_X B = \sum_i m(P_i^t)$ for t close to zero, where the sum runs over $\{i \mid \lim_{t \rightarrow 0} P_i^t \in X\}$. For a point $Q \in A$, we define $A \cdot_Q B$ as $A \cdot_X B$, where X is the connected component of Q in the intersection $A \cap B$.

Proposition 3.3.3 ([33] Proposition 3.11, see also [138] Corollary 12.12). For two curves $C_1, C_2 \in \mathbb{K}^2$ we consider a compact connected component X of the intersection $\text{Trop}(C_1) \cap \text{Trop}(C_2)$. Then, $\sum_{x \in C_1 \cap C_2, \text{Val}(x) \in X} m(x) = \text{Trop}(C_1) \cdot_X \text{Trop}(C_2)$ where $m(x)$ is the multiplicity of the point x in the intersection $C_1 \cap C_2$.

Proof. Consider the equation $F(x, y) = 0$ of C_2 . We construct the non-Archimedean amoeba $m_{C_2}C_1$ of $\{(x, y, F(x, y)) \mid (x, y) \in C_1\}$. Then $\text{Trop}(C_1) \cdot_X \text{Trop}(C_2)$ is the sum of the weights of the vertical legs of $m_{C_2}C_1$ under X . The latter is equal to $\sum_{x \in C_1 \cap C_2, \text{Val}(x) \in X} m(x)$. \square

Remark 3.3.4. For non-compact connected components of the intersection we only have an inequality $\sum_{x \in C_1 \cap C_2, \text{Val}(x) \in X} m(x) \leq \text{Trop}(C_1) \cdot_X \text{Trop}(C_2)$.

3.3.1 Tropical Weil reciprocity law and the tropical momentum map

The aim of this section is to establish another fact in tropical geometry, obtained as a word-by-word repetition of a fact in classical algebraic geometry. Weil reciprocity law can be formulated as

Theorem 3.3.5. Let C be a complex curve and f, g be two meromorphic functions on C with disjoint divisors. Then $\prod_{x \in C} f(x)^{\text{ord}_g x} = \prod_{x \in C} g(x)^{\text{ord}_f x}$, where $\text{ord}_f x$ is the minimal degree in the

Taylor expansion (in local coordinates) of the function f at a point x : $f(z) = a_0(z-x)^{\text{ord}_f x} + a_1(z-x)^{\text{ord}_f x+1} + \dots, a_0 \neq 0$.

The products in this theorem are finite because $\text{ord}_g x, \text{ord}_f x$ equal to zero everywhere except finite number of points.

Definition 3.3.6. If f and g share some points in their zeros and poles sets, then we state this theorem as $\prod_{x \in C} [f, g]_x = 1$ and define the term $[f, g]_x = \frac{f(x)^{\text{ord}_g x}}{g(x)^{\text{ord}_f x}} = \frac{a_n^m}{b_m^n} \cdot (-1)^{nm}$ at a point x , where $f(z) = a_n(z-x)^n + \dots, g(z) = b_m(z-x)^m + \dots$ are the Taylor expansions of f, g at the point x .

Example 3.3.7. Let C be $\mathbb{C}P^1$ and f, g are polynomials

$$f(x) = A \prod_{i=1}^n (x - a_i), g(x) = B \prod_{j=1}^m (x - b_j) \quad (3.5)$$

with $a_i \neq b_j$. Then,

$$\prod_{x \in C} g(x)^{\text{ord}_f x} = B^{nm} \prod_{i=1, j=1}^{n, m} (a_i - b_j), \prod_{x \in C} f(x)^{\text{ord}_g x} = A^{nm} \prod_{i=1, j=1}^{n, m} (b_j - a_i) \quad (3.6)$$

and the difference is corrected by the term $[f, g]_\infty$, because f, g have a common pole at infinity.

Khovanskii studied various generalizations of the Weil reciprocity law and reformulated them in terms of logarithmic differentials [86], [87],[88]. The final formulation is for toric surfaces and seems like a tropical balancing condition, what is, indeed, the case. The symbol $[f, g]_x$ is related with Hilbert character and link coefficient, and is generalized by Parshin residues. Mazin [112] treated them in geometric context of resolutions of singularities⁹.

In order to study what happens after a modification we consider a tropical version of Weil theorem. We need to define tropical meromorphic function and $\text{ord}_f x$, see also [120].

Definition 3.3.8 ([119]). A tropical meromorphic function f on a tropical curve C is a piece-wise linear function with integer slope. The points, where the balancing condition is not satisfied, are poles and zeroes, and $\text{ord}_f x$ is the defect in the balancing condition by definition.

Example 3.3.9. The function $f = \max(0, 2x)$ on \mathbb{TP}^1 has a zero of multiplicity 2 at 0, i.e. $\text{ord}_f(0) = 2$ and $\text{ord}_f(+\infty) = -2$.

Theorem 3.3.10. Let C be a compact tropical curve and f, g be two meromorphic tropical functions on C . Then $\sum_{x \in C} f(x) \cdot \text{ord}_g x = \sum_{x \in C} g(x) \cdot \text{ord}_f x$.

Word-by-word repetition of the reasoning in Example 3.3.7 proves this theorem in the case $C = \mathbb{TP}^1$, because a tropical polynomial $f : \mathbb{T} \rightarrow \mathbb{T}$ can be presented as $f(x) = \sum \max(a_i, x)$ where a_i are the roots of f .

For the general statement there are many proofs (and one can proceed by studying piece-wise linear functions on a graph), we give here the shortest¹⁰ one, via so-called *tropical momentum*.

⁹Unfortunately, tropical analog of this problem has no big interest: Parshin residues are destined for non-transversal intersection, in order to define local residues. That suggests that Mazin's resolution of singularities is a classical version of tropical modifications. Probably, tropical approach can repeat classical results, and better visualize the different types of non-transversality for higher-dimensional varieties.

¹⁰and using tropical modifications

Suppose that C is a planar tropical curve. We list all the edges E_1, \dots, E_k of C , suppose that their directions are given by primitive¹¹ integer vectors v_1, \dots, v_n . Suppose that each edge E_i has weight m_i and if E_i is infinite, then the direction of v_i is chosen to be "to infinity" (there are two choices and for us the orientation of v_i will be important). Let A be a point on the plane. Let $B_i \in E_i$.

Definition 3.3.11 ([169]). Tropical momentum of an edge E_i of C with respect to the point A is given by $\rho_A(E_i) = m_i \cdot \det(v_i, AB_i)$.

Definition 3.3.12. For a point $A \in \mathbb{R}^2$ define $\rho_A(C)$ as $\sum_E \rho_A(E)$ where E runs over all infinite edges of C .

Lemma 3.3.13. If a tropical curve C has only one vertex, then $\rho_A(C) = \sum_{i=1}^k \rho_A(E_i) = 0$ for any point A on the plane.

Proof. First of all, $\sum_{i=1}^k \rho_A(E_i)$ does not depend on the point A , because if we translate A by some vector u , then each summand in $\rho_A(C)$ will change by $\det(v_i, u) \cdot w_i$ and the sum of changes is zero because of the balancing condition. Therefore, $\rho_A(C) = 0$, because we can place A in the vertex of this curve. \square

Lemma 3.3.14 (Moment condition in [169], also it appeared in [118] under the name Tropical Menelaus Theorem). For an arbitrary plane tropical curve $C \subset \mathbb{R}^2$ and any point $A \in \mathbb{R}^2$ the equality $\rho_A(C) = 0$ holds.

Proof. Note that the total momentum for a curve is the sum of momenta for all vertices, because a summand corresponding to an edge between two vertices will appear two times with different signs. So, this lemma follows from the previous one. \square

Definition 3.3.15. We consider a tropical curve $C \subset \mathbb{T}^3$. Let E_1, E_2, \dots, E_n be its infinite edges. We define the momentum of C with respect to A as $\rho(A) = \sum_{i=1}^n (v_i \times AB_i) \cdot m_i$ where \times stands for the vector product, v_i is the primitive vectors (in the direction "to infinity") of an edge E_i , m_i is the weight of E_i and B_i is a point on E_i .

Proposition 3.3.16 (Generalized Tropical Menelaus theorem). For a tropical curve $C \subset \mathbb{T}^3$ and any point A , the total tropical momentum $\rho_A(C)$ of C with respect to A is zero.

Proof. We proceed as in the planar case. We show that $\rho_A(C)$ does not depend on A because of the balancing condition. Indeed, if C has only one vertex, then the claim is trivial. In general case we sum up the tropical momentum by all the edges, and the terms for internal edges appear two times with different signs, which concludes the proof. \square

An application of this theorem can be found in Example 3.2.17.

¹¹i.e. non-multiple of another integer vector

3.3.2 Application of the tropical momentum to modifications.

Example 3.3.17. Consider the graph of a tropical polynomial $f(x) = \max(a_0, a_1 + X, \dots, a_n + nX)$. Suppose that we know only a_0 and a_n . Definitely, the positions of the roots of f may vary, being dependent on the coefficients of f . Nevertheless, we can apply the tropical Menelaus theorem for the graph of f . We will calculate the momentum with respect to $(0, 0)$. This graph has one infinite horizontal edge with momentum a_0 and one edge of direction $(1, n)$ with the momentum $-a_n$. Also, for each root $p_i \in \mathbb{T}$ of f we have an infinite vertical edge with the momentum $-p_i$. Application of the tropical moment theorem gives us $\sum p_i = a_0 - a_n$, which is simply a tropical version of the Vieta theorem — the product of the roots p_i of a polynomial $\sum_{i=1}^n a_i x^i$ is a_0/a_n .

On the Fig. 3.5b, 3.6a, *a priori* we know only the sum of directions of edges with endpoints on the modified curve. We know that there is no horizontal infinite edges (in these examples). In general, it is possible, if the intersection of two initial curves is non-compact. Therefore by Weil theorem (or tropical Menelaus Theorem, they are the same) we know the sum of x -coordinates of vertical infinite edges. Thus the sum of weights for red vertical edges equals the sum of vertical components of the black edges in the Figure 3.6b.

Lemma 3.3.18. While doing a modification along horizontal line, the total vertical slope is the total horizontal slope on the dual picture.

Proof. The same as for Proposition 3.3.1. □

Lemma 3.3.19. If the stable intersection of $\text{Trop}(C)$ with a horizontal line L is equal to m and there exists a point $q \in C$ with $\mu_q(C) \geq m$ and $\text{Val}(q) \in \text{Trop}(C) \cap L$, then we can uniquely recover the position of $\text{Val}(q)$.

Proof. Indeed, consider a lift l of L which passes through q . If we make the modification along l , we obtain a leg of $m_L(\text{Trop}(C))$ of weight at least m under $\text{Trop}(C) \cap L$. Since the stable intersection $\text{Trop}(C) \cap L$ is equal to m , this is the only leg under $\text{Trop}(C) \cap L$. Therefore, the tropical momentum theorem gives us the unique position of this leg (of course, it is evident via balancing — we know all the infinite edges of a tropical curve except one, therefore the coordinates of this last edge can be found via the balancing condition). □

Proposition 3.3.20 (see [33], Proposition 4.5). For each compact connected component C of $C_1 \cap C_2$ the sum of X coordinates (and the sum of Y -coordinates) of the valuations of the intersection points of C_1, C_2 with valuations in C , can be calculated just by looking on behavior of C_1 and C_2 near C .

Indeed, we use tropical Menelaus theorem, this gives us sum of the momenta of all the legs of $m_{C_2} C_1$ going to $-\infty$ by Z -coordinate.

3.3.3 Proof of the tropical Weil theorem

We carry on with a proof of the tropical Weil theorem. Given two tropical meromorphic functions f, g on a tropical curve C we want to define the map $C \rightarrow \mathbb{T}P^2, x \rightarrow (f(x), g(x))$ and then use tropical Menelaus theorem. Here we have to use tropical modification, because *a priori*, the image of tropical curve under the map $(f, g) : C \rightarrow \mathbb{T}^2$ with f, g tropical meromorphic functions, is **not** a plane tropical curve: balancing condition is not satisfied near zeroes and poles of f and g .

Definition 3.3.21. We call a triple (C, f, g) of a tropical curve C and two meromorphic function $f, g : C \rightarrow \mathbb{TP}^1$ on it *admissible* if all the zeroes and poles of f, g are located at different one-valent vertices of C .

Lemma 3.3.22. Given a triple (C, f, g) of a tropical curve C and two meromorphic function $f, g : C \rightarrow \mathbb{TP}^1$ on it, we always can extend the function f, g on the modification $D = m_{\text{div}(f), \text{div}(g)} C$ of C , such that the obtained triple (D, f', g') is admissible and

$$\sum_{x \in C} f(x) \cdot \text{ord}_g x - \sum_{x \in C} g(x) \cdot \text{ord}_f x = \sum_{x \in D} f'(x) \cdot \text{ord}_{g'} x - \sum_{x \in D} g'(x) \cdot \text{ord}_{f'} x. \quad (3.7)$$

Proof. We perform tropical modifications of C in order to have all zeros and poles of f, g at the vertices of valency one. Namely, for a point p such that p is in the corner locus of f we add to C an infinite edge l emanating from p . We define f on l as the linear function with integer slope such that the sum of slopes of f over the edges from p is zero, i.e. $f(p') = f(p) - \text{ord}_f p \cdot p'$ where p' is a coordinate on l such that $p' = 0$ at p and then grows. We define g on this edge as the constant $g(p)$. We perform this operation for all roots and poles of f . Then we do the symmetric procedure for g . \square

Proof of the tropical Weil theorem. By the lemma above we may suppose that the triple (C, f, g) is admissible. Now f, g define a map $C \rightarrow \mathbb{T}^2$ and the image is a tropical curve $D = (f(x), g(x)) | x \in C$: indeed, at every vertex of the image the balancing condition is satisfied; all one-valent vertices go to infinity by one the coordinates. Now it is easy to verify that $g(x) \cdot \text{ord}_f(x)$ is a term in the definition of the momentum of D with respect to $(0, 0)$: if $\text{ord}_f(x) \neq 0$, then D has a horizontal infinite edge, and its y -coordinate is $g(x)$. Finally,

$$\sum_{x \in D} f(x) \cdot \text{ord}_g x - \sum_{x \in D} g(x) \cdot \text{ord}_f x = \rho((0, 0)) = 0. \quad (3.8) \quad \square$$

Remark 3.3.23. If f, g come as limits of complex functions f_i, g_i , having $\text{ord}_{f_i}(p_i) = k, \text{ord}_{g_i}(p_i) = m, \lim p_i = p$, then the tropicalization of $\{(f_i(x), g_i(x)) | x \in C_i\}$ will not have vertical (with multiplicity k) and horizontal (with multiplicity m) leg from a common divisor point p of f and g , but will have one leg of direction (k, m) . Nevertheless, because of the tropical Menelaus theorem or the balancing condition, it has no influence on the (3.8).

3.3.4 Difference between stable intersection and any other realizable intersection

One may ask if the only obstruction for a modification is the generalized tropical Menelaus theorem? As we will see in this section, not at all.

Let us start with a variety $M' \subset \mathbb{K}^n$ and a hypersurface $N' \subset \mathbb{K}^n$ and their non-Archimedean amoebas $M, N \subset \mathbb{T}^n$. We suppose that the intersection of M with a tropical hypersurface N is not transverse. We ask: how does the non-Archimedean amoeba of intersections of $M' \cap N'$ looks like?

First of all, as a divisor on M (or N) it should be rationally equivalent to the divisor of the stable intersection of M and N , as it shown for the case of curves in [122]. In the general case it follows from the results of this section.

It is easy to find some additional necessary conditions. Let us restrict on M' the equation F of N' , and take the valuations of all these objects M', N', F . We get some function $f = \text{Trop}(F)$ whose behavior on a neighborhood of $N \cap M$ is fixed but its behavior on M is under the question.

Definition 3.3.24. Let M be an abstract tropical variety and an embedding $\iota : M \rightarrow \mathbb{T}^n$ be its realization as a tropical subvariety of \mathbb{T}^n . Let f is a tropical function on \mathbb{T}^n . We define the pull-back of $\iota^*(f)$ to M as $f \circ \iota$. We call $\iota^*(f)$ *frozen* at a point $p \in M$ if f is smooth at $\iota(p)$.

Note that in general the slopes of f on $\iota(M)$ does not coincide with slopes of $\iota^*(f)$ on M . From now on we consider tropical functions which have frozen points, the motivation is explained in the following definition.

Definition 3.3.25. A principal divisor P on an abstract tropical variety M is called *subordinate* to a principal divisor Q (we write $P \prec Q$), which is defined by a tropical meromorphic function f with frozen points, if P can be defined by a tropical meromorphic function h , which satisfies $h \leq f$ everywhere and $h = f$ at the points where f is frozen.

Remark 3.3.26. As it is easy to see, the fact of being subordinate depends only on P, Q , and does not depend on particular choice of f, h as long as the sets of frozen points in M is fixed.

Example 3.3.27. Refer to Example 3.2.19.

Now, let us start from the tropical curve M given by

$$\max(3+X+3Y, 3+X+2Y, 3+X+Y, 3+X, 2+2X+2Y, 2+2X+Y, 2+2X, 1+Y, 1, 3X-2) \quad (3.9)$$

and a horizontal line N given by $\max(Y, 0)$. We want to understand the valuations of possible intersections of $M' \cap N'$ where $\text{Trop}(M') = M, \text{Trop}(N') = N$.

We can choose the equation for M' in the form

$$F(x, y) = (t^{-1} + \alpha_0 + t^{-1}y) + x(t^{-3} + \alpha_1 + t^{-3}y^3) + x^2(t^{-2} + \alpha_2 + t^{-2}y) + x^3(t^2 + \alpha_3), \quad (3.10)$$

where $\text{val}(\alpha_0) < 1, \text{val}(\alpha_1) < 3, \text{val}(\alpha_2) < 2, \text{val}(\alpha_3) < -2$. It is clear, that for any $A \leq 1, B \leq 3, C \leq 2$ by choosing y of the form $1 + \alpha, \text{val}(\alpha) < 0$ and then with careful choice for $\alpha_1, \alpha_2, \alpha_3$ we can obtain (see Figure 3.9)

$$f(X) = \text{Val}(F(x, 1 + \alpha)) = \max(A, B + X, C + 2X, -2 + 3X). \quad (3.11)$$

In this example the set $X \geq 4$ on N is frozen for $\text{Trop}(F)$, that is why we have a choice for the constant term A . If the intersection is a compact set (as in Example 3.2.13), then the constant term is also fixed. Note that for the stable intersection our tropical function is $\text{Trop}(F)(X, 0) = \max(1, 3 + X, 2 + 2X, -2 + 3X)$ and $f(X) \leq \text{Trop}(F)(X, 0)$ at every point.

Now we prove the following theorem whose proof consists only in a reformulation in the language of tropical modifications and staring to the pictures, see Remark 3.2.14 as an illustration.

Fix an abstract tropical variety M , its tropical embedding $\iota : M \rightarrow \mathbb{T}^n$, and a tropical hypersurface $N \subset \mathbb{T}^n$, given by a tropical function f . As we know, the pullback of the divisor of the stable intersection of $\iota(M)$ with N is given by $\iota^*(f)$. Note that the function $\iota^*(f)$ has frozen points by Definition 3.3.24.

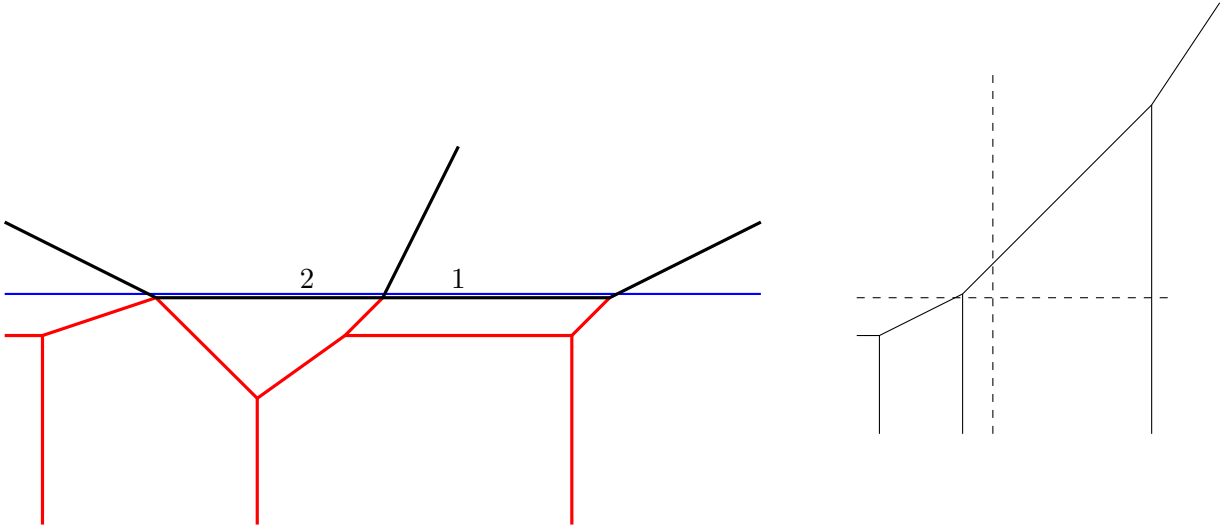

Figure 3.9: Refer to Example 3.3.27. On the left figure we see the vertical part of the modification of the curve given by $F(x, y) = (-t^{-1} + t^{5/3} + t^{-1}y) + x(t^{-3}y - (t^{-3} + t^{-5/6})) + x^2(t^{-2}y - t^{-2} + t^{-3/2}) + x^3t^2$ along the line $y = 1$. On the right figure we see the tropicalization of the restriction of F on $y = 1$, i.e. the function $\max(3X - 2, 2X + 1.5, X + 5/6, -5/3)$.

Theorem 3.3.28. In the above hypothesis, if N' and M' are such that $\text{Trop}(N') = N$, and $N' \subset (\mathbb{K}^*)^n$ is given by an equation $F = 0$, and $\text{Trop}(M') = M$, $M' \subset (\mathbb{K}^*)^n$, then the pullback of $\text{Val}(N' \cap M')$ to M is subordinate (Definition 3.3.25) as a divisor to the divisor of $\iota^*(f)$ (Definition 3.3.24).

Proof. Let $f = \text{Trop}(F)$, $f : \mathbb{T}^n \rightarrow \mathbb{T}$. Let us make the modification of \mathbb{T}^n along N . Look at the image $m_f(M)$ of M under this map. Clearly, the valuation of the set $\{(x, F(x)) | x \in M'\}$ belongs to $m_f(M)$, therefore the graph of the function $\text{Trop}(F|_{M'})$ on M belongs to $m_f(M)$. Also, $\text{Trop}(F|_{M'})$ coincides with f at the points where f is smooth. Therefore the pullback of $\iota^*(\text{Trop}(F|_{M'}))$ is at most $\iota^*(f)$ everywhere, and $\iota^*(\text{Trop}(F|_{M'})) = \iota^*(f)$ at the points where $\iota^*(f)$ is frozen. So, the divisor of $\iota^*(\text{Trop}(F|_{M'}))$ on M is subordinate to the pullback of the stable intersection by definition. \square

The graph of $\text{Trop}(F|_{M'})$ can be lower than the graph of $\text{Trop}(F)|_M$ because when we substitute the points on M' to F , some cancellation can occur, which are invisible when we consider F as a function on \mathbb{K}^n . Recall that if the image of the valuation map val is \mathbb{T} , we know that $\text{Trop}(F)(X)$ is the maximum of $\text{val}(F(x))$ with $\text{Val}(x) = X$. On the other hand, $\text{Trop}(F|_{M'})(X)$ for $X \in M$ is the maximum of $\text{val}(F(x))$ with $\text{Val}(x) = X$ and $x \in M'$. Clearly, the latter maximum is at most the former maximum.

Example 3.3.29. Refer to Figure 3.10. We have the stable intersection $A + B + C + D$ of the curves given by $\max(0, y)$ and $\max(0, x, 2x - 1, 3x - 3, 4x - 6, x + y, 2x + y - 1, 3x + y - 3)$. The divisor $A + B' + C' + D$ is rationally equivalent to $A + B + C + D$, the function which participate in this rational equivalence is bigger than the function $\max(0, x, 2x - 1, 3x - 3, 4x - 6)$ coming from the restriction.

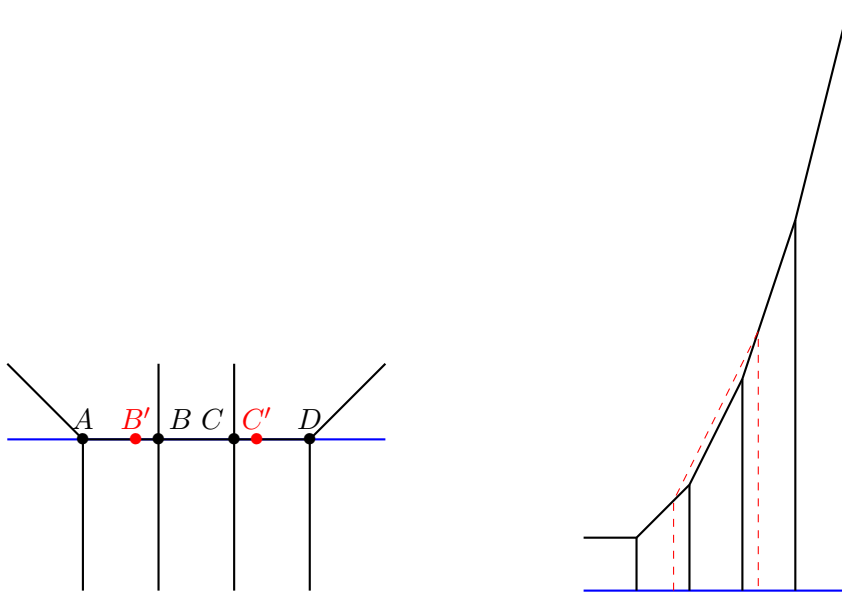

Figure 3.10: The divisor $A + B' + C' + D$ is not-realizable as the intersection of the lifts of the curves defined by $\max(0, y)$ and $\max(0, x, 2x - 1, 3x - 3, 4x - 6, x + y, 2x + y - 1, 3x + y - 3)$. On the right we see the function which carries this rational equivalence out, is it bigger than the function for the stable intersection.

3.3.5 Interpretation with chips

In the case of curves we can represent a divisors on a curve by a collection of chips. In the last subsection we proved Theorem 3.3.28 which says that any realizable intersection is subordinate to the stable intersection. So, one might ask for a method to produce all the subordinate divisors to a given divisor (though, it is possible that not all of them are realizable as the valuation of an intersection).

Let us start with the stable intersection of two tropical curves, this intersection is a divisor (collection of chips) on the first curve. Then we allow the following movement: pushing continuously together two neighbor chips on an edge, with equal speed. We do not allow the opposite operation — when we slide continuously two points apart from each other (so, the operation in Figure 3.10 does not provide a subordinate to $A + B + C + D$ divisor).

This corresponds to the following: we look at the modification of the first curve along the second curve, given by a tropical polynomial $\text{Trop}(F)$. By decreasing the coefficients of the monomials in $\iota^*(f)$ on C , one by one, we can obtain any function less than $\iota^*(f)$.

This reasoning can be applied to the intersection of any two tropical varieties, if one of them is a complete intersection. We restrict the equations of the second variety on the first, that give us a stable intersection, then we have a situation similar to Definition 3.3.25.

Example 3.3.30. Consider the function $\max(0, x - 1, 2x - 3)$. This function defines the divisor on \mathbb{T}^1 with two chips, one at 1 and the second at 2. When we decrease the coefficient in the monomial

$x - 1$, these chips are moving closer. For example the function $\max(0, x - 1.3, 2x - 3)$ defines the divisor with chips at the points with the coordinates 1.3 and 1.7.

Remark 3.3.31. Note that if the stable intersection is not compact that we need to add a chip at infinity (or to treat infinity as a point with one chip). Now let A, B be two chips, A is at infinity and B is on the leg of V going to A . Then, pushing together A, B moves only B towards infinity. This corresponds to decreasing the constant term in Example 3.3.27.

Example 3.3.32. Big order tangency with only two degrees of freedom. ([33], Lemma 3.15). We consider a line $y - \alpha x - \beta = 0, \text{val}(\alpha) = 0, \text{val}(\beta) = 0$ and a curve $a_0 + a_1y + a_2xy^l = 0$ with $\text{val}(a_0) = 0, \text{val}(a_1) = 0, \text{val}(a_2) = 0$.

Clearly, we have non-transversal intersection, we can perform substitution $y = \alpha x + \beta$, that gives $a_0 + a_1(\alpha x + \beta) + a_2x(\alpha x + \beta)^l = (a_0 + a_1\beta) + x(a_1\alpha + a_2\beta^l) + \sum_{i=2}^{l+1} a_2\beta^{l+1-i}\alpha^{i-1}x^i$. The contraction may only appear at two coefficients: the coefficient before x and the constant term. So we have only two degrees of freedom. Let us present the intersection points as chips. By changing the coefficients α, β, a_i we change the intersection, so we can look at how the chips move. So, when $\text{val}(a_0 + a_1\beta) < \text{val}(a_0)$, this correspond to the movement in Remark 3.3.31, one chip moves towards infinity while the others do not move at all. Also we can push two chips together by decreasing the valuation of $a_1\alpha + a_2\beta^l$. Note that $l - 2$ chips at the point $(0, 0)$ are unmovable.

Here we have only two degrees of freedom because we have only two degrees of freedom in the equation $a_0 + a_1y + a_2xy^l = 0$.

Question 13. Motivated by the above example, we give the following suggestions which seems to be reasonable for the realizability of intersections. Suppose we have a tropical line and a curve defined by f . While defining $\iota^*(f)$ we keep track of all the monomials m_i of f and then in Definition 3.3.25 we allow g to contain only monomials of the type $\iota^*(m_i)$. I.e. if $f = \sum a_{ij}x^i y^j$, then we only allow g of the type $\max(c_{ij} + \iota^*(x^i y^j))$ with $c_{ij} \leq \text{val}(a_{ij})$ which coincides with f on the frozen set of f . We explain why we restricted to the case when one of the curves is a line. Normally, we can perturb the coefficients of the equations of both curves. If one of the curves is a line, we can always suppose that its equation is fixed. For the general case, one should expect that apart from $\iota^*(f)$ on M we can find another thin structure s , which responds for deformation of the equation of M being immersed to \mathbb{T}^n , something like “a pull-back of the normal bundle”, coming from the map ι .

Example 3.3.33. Difference between a leg of big weight and a root. Take the curve C given by $F = 0$ where $F(x, y) = 1 + (t^{-1} + t)x + (2t^{-1} + t^2 + t^4)x^2 + (t^3 + 2t^4)x^3 + t^{-1}xy + 2t^{-1}x^2y$ and intersect it with the line given by $t^5x + y + 1 = 0$.

Performing the tropical modification along the line we see that the resulting curve has a leg of weight three going to $-\infty$. But it is not a root of multiplicity three! If we substitute $y = -1 - t^5x$ to the equation, we will see that the obtained polynomial $1 + tx + t^2x^2 + t^3x^3$ has three roots of the valuation 1, but they do not coincide. But if we consider the curve C' given by the equation $F = 0, F(x, y) = 1 + (t^{-1} + 3t)x + (2t^{-1} + 3t^2 + t^4)x^2 + (t^3 + 2t^4)x^3 + t^{-1}xy + 2t^{-1}x^2y$, we see that $\text{Trop}(C) = \text{Trop}(C')$ and C' has a tangency of order three with the line.

The same example can be constructed for the similar Newton polygon $(0, 0) - (1, 1) - (n, 1) - (n + 1, 0)$, where we also can obtain the tangency of the order $n + 1$.

Question 14. Suppose that the intersection of a tropical line with a tropical curve is a segment. Is it always possible to make a modification in order to have a leg of the weight equal to local stable intersection (Definition 1.7.1)? If yes, is it always possible to find the coefficients for the equations in order to have a tangency of the order equal to the stable intersection? Also, we can ask this question for any two curves with non-transverse intersection.

Due to combinatorial restrictions in tropical terms, sometimes we can see that it is impossible to have a singular point with high multiplicity on a curve. Note that even in this case we can have a leg of big multiplicity after the modification, see Example 3.3.33.

3.3.6 Digression: generalizations of the tropical momentum

A natural generalization of the vector product (or cross product) in \mathbb{R}^3 ,

$$(x_1, y_1, z_1) \times (x_2, y_2, z_2) = (y_1 z_2 - y_2 z_1, x_2 z_1 - x_1 z_2, y_1 z_2 - y_2 z_1) \quad (3.12)$$

is the following. Given k vectors $v_1, v_2, \dots, v_k \in \mathbb{R}^n, k \leq n$ we consider the vector consisting of all the minors $k \times k$ of the matrix $k \times n$ constructed as the matrix with the vectors v_1, \dots, v_k as rows. We call this vector of minors *generalized cross product* of v_1, v_2, \dots, v_k .

Consider a tropical variety $V^k \in \mathbb{T}^n, k < n$. Let us choose a basis in all faces of V of codimension one and zero, i.e. for a face F we chose a basis in the lattice associated with the integer affine structure of this face. For each face G of codimension one in V and the faces F_1, F_2, \dots, F_l of codimension zero, containing G , we choose vectors $v_G(F_i)$ which participate in the balancing condition along G . Now we can define the sign $s_G(F) \in \{+1, -1\}$ which is $+1$ if the basis in G with added vector $v_G(F)$ at the last place gives the same orientation in F as the basis in F , and -1 otherwise.

Definition 3.3.34. Let $\mathfrak{G}(V)$ be the abelian group generated formally by all the faces G of V of codimension one. For a face $F \subset V$ of maximal dimension define $m(F) \in \mathfrak{G}(V)$ to be the sum $\sum_{G \subset F} s_G(F) \cdot G$. For each bounded face $F \subset V$ of maximal dimension we add the relation $m(F) \in \mathfrak{G}(V)$.

Definition 3.3.35. Let A be a point in \mathbb{T}^n . Pick a face F of V of codimension zero and let B be a point in F . Then, define $r_A(F)$ as the generalized cross product of the vector AB and the vectors in the basis in F . Finally, define

$$\rho_A(F) = r_A(F) \otimes_{\mathbb{Q}} m(F) \in \mathbb{R}^{\binom{n}{k+1}} \otimes_{\mathbb{Q}} \mathfrak{G}(V). \quad (3.13)$$

Proposition 3.3.36. For any point $A \in \mathbb{T}^n$ we have $\sum_F \rho_A(F) = 0$, where F runs over all the unbounded faces of V of the maximal dimension.

Proof. In spirit, the proof is the same as in Lemma 3.3.13. We consider the sum of the momenta for all the faces F of V of maximal dimension. We show that $\sum \rho_A(F)$ does not depend on the point A . Indeed, for each face G of the codimension one we consider the terms in $\sum \rho_A(F)$ which contain G . It is easy to see, that thanks to the balancing condition along G and our choice of signs, the sum of these terms is zero. \square

Example 3.3.37. Compare Definition 3.3.35 with the proof of Lemma 3.3.14. For the case of planar tropical curve C the group $\mathfrak{G}(V)$ is generated by all the vertices of C . Then, each internal edge of C gives the relation that its ends are equal. Therefore, in that case the group $\mathfrak{G}(V)$ is \mathbb{Z} with generator $\mathbf{1}$ and for each unbounded F we have $m(F) = \mathbf{1}$.

Question 15. It seem that in general situation, if V is a tropical curve, then, again, $\mathfrak{G}(V)$ is \mathbb{Z} . On the other hand, it seems that if the dimension of V is at least two, then $\mathfrak{G}(V)$ is freely generated for the unbounded faces of V of codimension 1.

3.4 Applications of a tropical modification as a method

3.4.1 Inflection points.

An inflection point of a curve is either its singular point, or a point where the tangent line has order of tangency at least 3. It was known before that the number of real inflection points on a curve of degree d is at most $d(d - 2)$ and the maximum is attainable. The question, attacked in [33] is *which topological types of planar real algebraic curves admits the maximal number of real inflection points?* Using classical way to construct algebraic curves – Viro’s patchworking method – the authors construct examples, for what they study possible local pictures of tropicalizations of inflection points. The property to be verified is tangency, but intersection of tropical curve with a tangent line at some point in most cases is not transversal and it is not visible what is the actual order of tangency. To see that, the authors do tropical modifications.

3.4.2 The category of tropical curves

For the treatment of this question with tropical harmonic maps see [5, 6]. G. Mikhalkin defines the morphisms in the category of tropical curves as all the maps, satisfying the balancing and Riemann-Hurwitz conditions (see, for example [19]) and subject to the *modifiability* condition:

Definition 3.4.1. A morphism $f : A \rightarrow B$ of tropical curves A, B is said to be *modifiable* if for any modification B' of B there exists a modification A' of A and a lift f' of f which makes the obtained diagram commutative.

Proposition 3.4.2. The modifiability condition ensures that a morphism came as a degeneration of maps between complex curves (see Section 3.1.1).

Sketch of a proof. After a number of modifications we may have the map f' contracting no cycles. Then we construct a family of complex curves B_i such that $\lim B_i = B'$ in the hyperbolic sense (see section 3.1.1). Finally, since f' should come as a tropicalization of a covering, the complex curves A_i with $\lim A_i = A'$ are constructed as coverings $f_i : A_i \rightarrow B_i$ over B_i where the combinatorics (ramification profiles, local degrees at points of tori contracting to tropical edges) of f_i is prescribed by f' . Balancing and Riemann-Hurwitz conditions follow. \square

3.4.3 Realization of a collection of lines and (4,d)-nets

Which configuration of lines and points in \mathbb{P}^2 with given incidence relation are possible? That is a classical question and even for seemingly easy data the answer is often not clear.

Definition 3.4.3. A $(4, d)$ -net in \mathbb{P}^2 is four collections by d lines each of them, such that exactly four lines pass through any point of intersection of two lines from different collections, all these four lines are from different collections.

It is not clear whether a $(4, d)$ -net exists for $d \geq 5$. In [70] the authors proved, using tropical geometry, that there is no $(4, 4)$ -net.

The one of the key ingredients is the following: if some net exists in the classical world, then it exists in the tropical world. The problem is the following: if we have more than three tropical lines through a point on a plane, then the intersection will be non-transversal. But thanks to modifications we always can have transversal intersection, but probably in the space of bigger dimension. For that we just do modification along lines which has non-transversal intersection, after this modification, all intersections with it become transversal and the modified lines goes to infinity. Then, let us think about the following theorem, announced by the authors of [70], from the point of view of modifications:

Question 16. If for some combinatorial data of intersection of linear spaces can be realized in \mathbb{P}^k , does there exists a tropical configuration of tropical linear spaces which realize the same data in $T\mathbb{P}^{k'}$ with $k' \geq k$?

Indeed, consider the realization in \mathbb{P}^k . By passing to the tropical limit we obtain a tropical configuration, but the intersection dimensions may increase. Then, by doing the modifications, we want repair the right dimensions.

3.4.4 A point of big multiplicity on a planar curve.

In its most general form, this question could be formulated as follows: given a cohomological class a of subvariety S in a bigger variety, how many singularities S may have? For example, is it possible for a surface of degree 4 in $\mathbb{C}P^4$ to have four double points and three two fold lines?

There are several reasons for tropical geometry could provide tools for such questions. We will demonstrate these tools in the case of curves, where this deed has been already done. Combinatorics of a tropical curve is encoded in the subdivision of its Newton polygon. In fact, a singular point of multiplicity m influences a part of the subdivision of area of order m^2 , what is in accordance with the order of the number of linear conditions $\binom{m(m+1)}{2}$ that a point of multiplicity m imposes on the coefficients of the curve's equation. For a general treatment of the tropical singularities, see [80],[81] and Chapters 1,2.

In this section we will only demonstrate how to apply modification technic in this problem, though we will obtain weaker estimation – but still of order m^2 .

The idea is the following: if a curve C has a point p of multiplicity m , then for each curve D , passing through p , the local intersection of C and D at p is at least m . The multiplicity of a local intersection of C and D can be estimated from above by studying the connected component, containing $\text{Val}(p)$, of the stable intersection $\text{Trop}(C) \cap \text{Trop}(D)$ for the non-Archimedean amoebas of C and D , see Theorem 3.3.3.

So, the method: we take the polynomial F defining D , and use the fact that the image of C under the map $m_D : (x, y) \rightarrow (x, y, F(x, y))$ intersects the plane $z = 0$ with multiplicity at least m . That implies **existence** of a modification of $\text{Trop}(C)$ along $\text{Trop}(D)$, which has a leg of weight m

going in the direction $(0, 0, -1)$, exactly under the point $\text{Val}(p)$. The latter modification is obtained just by taking the non-Archimedean amoeba of $m_D(C) \subset m_D(\mathbb{P}^2)$.

Now we reduce the problem for its combinatorial counterpart: is it possible for two given tropical curves, that after the modification along the second, the first curve will have a leg of weight m , which projects exactly on the given point $\text{Val}(p)$? After some work with intrinsically tropical objects, we will get an estimate of this point's influence on the Newton polygon of the curve.

We are not going to consider this problem in the full generality, so we will have a close look at the simplest interesting example. Suppose that $\text{Val}(p)$ is inside some edge E of the tropical curve $\text{Trop}(C)$ and this edge is horizontal.

Suppose that p is of multiplicity m for C . Let us take a line D through p , such that $\text{Trop}(D)$ contains $\text{Val}(p)$ inside its vertical edge. Clearly the intersection $\text{Trop}(C) \cap \text{Trop}(D)$ is one point, and the multiplicity of this point should be at least m . That immediately implies that the weight of E is at least m . Hence the lattice length of $d(E)$ is at least m . (Cf. with Proposition 1.7.6 and Proposition 1.7.8.)

If we consider the modification of C along the horizontal line L , then the contribution to the edge of direction $(0, 0, -1)$ consists of the horizontal components of the edges which intersect $C \cap L$ at exactly one point, see Example 3.2.19 and Proposition 1.7.7.

What to do if there is a rational component, a part of C , through $\text{Val}(p)$? We perform the modification along the horizontal line L . If a part of the curve goes to the minus infinity, that means that we can divide the equation of F by some degree of L . That means that the Newton polygon of C has two parallel vertical sides. The components which do not go to the minus infinity do not contribute to the singularity.

Let \mathfrak{E} be the stable intersection of $\text{Trop}(C)$ and the horizontal line; clearly $E \subset \mathfrak{E}$ (cf. with notation in Section 1.9.1). Now, let us compute the sum of the areas of the faces $d(V)$ corresponding to vertices V of $\text{Trop}(C)$ on \mathfrak{E} . It is possible that more than two faces correspond to one singular point, if the edge with the singular point has an extension, see again Example 3.2.19.

First of all, we consider the simplest case.

Proposition 3.4.4 (cf. Proposition 1.7.8). Suppose that a horizontal edge E contains a point $\text{Val}(p)$ of multiplicity m . Suppose also that the vertical edge $d(E)$ is dual to E in the dual subdivision of the Newton polygon. Let the endpoints of E be A_1, A_2 and two faces $d(A_1), d(A_2)$ adjacent to $d(E)$ have no other vertical edges. Then the sum of widths of the faces $d(A_1), d(A_2)$ is at least m , so their total area is at least $m^2/2$.

Proof. Let us look at the dual picture in the Newton polygon. Two faces $d(A_1), d(A_2)$ adjacent to the vertical edge have the sum of width in the $(1, 0)$ direction at least m (by Proposition 3.3.1), $d(E_1)$ has length m , so the sum of the areas of $d(A_1), d(A_2)$ is at least $m^2/2$. \square

Remark 3.4.5. Note that if the stable intersection of $\text{Trop}(C)$ with the horizontal line is m , then we can uniquely determine the position of the valuation of the singular point, see Lemma 3.3.19.

Suppose that a tropical curve has edges $A_1A_2, A_2A_3, \dots, A_{k-1}A_k$ and A_1, A_2, \dots, A_k are situated on a horizontal interval $A_1A_k = \mathfrak{E}$. Suppose that p , point of multiplicity m , is on the edge A_sA_{s+1} . The method above doesn't work. Indeed, we compare this situation to Section 1.9.1. Making a modification along a **line** containing A_1A_k in the horizontal ray we estimate only the common width

of faces corresponding to A_1, A_2, \dots, A_k , which gives no good estimate for the sum of areas of $d(A_i)$ (cf. Proposition 1.7.7).

So we will make a modification along a quadric.

Lemma 3.4.6. In the hypothesis above the sum of areas of all faces $d(A_1), d(A_2), \dots, d(A_k)$ is at least $m/2 + m^2/4$.

Proof. Let a_i be the width of i -th face on the right (i.e. $a_i = \omega_{(1,0)}(d(A_{s+i}))$ for $i \geq 1$), b_i be the width of i -th face on the left (i.e. $a_i = \omega_{(1,0)}(d(A_{s-i}))$ for $i \geq 0$), c_i be the length of i -th vertical edge on the right (i.e. $c_i = \omega_{(0,1)}d(A_{s+i}A_{s+i+1}), i \geq 1$), d_i be the length of the i -th vertical edge on the left (i.e. $c_i = \omega_{(0,1)}d(A_{s-i}A_{s-i+1}), i \geq 1$). Then, let $\sum_{i=1}^k a_i = A_k, \sum_{i=1}^k b_i = B_k$. With the same calculations as above, making the modification along a piece of a quadric with vertices on $A_{s-j}A_{s+1-j}$ and $A_{s+i}A_{s+1+i}$ we get $A_i + c_i + B_j + d_j \geq m$. Denote $\min_i(c_i + A_i) = A, \min_i(d_j + B_j) = B$, so $A + B \geq m$.

Then, $c_i \geq A - A_i, d_j \geq B - B_j$. Sum S of areas can be estimated as

$$2S \geq (m + c_1)A_1 + \sum (A_{i+1} - A_i)(c_i + c_{i+1}) + (m + d_1)B_1 + \sum (B_{i+1} - B_i)(d_i + d_{i+1})$$

$$2S \geq (m + A - A_1)A_1 + \sum (A_{i+1} - A_i)(A - A_i + A - A_{i+1}) +$$

$$(m + B - B_1)B_1 + \sum (B_{i+1} - B_i)(B - B_i + B - B_{i+1}) \geq$$

$$A_1(m - A) + A^2 + B_1(m - B) + B^2 \geq m + m^2/2.$$

So, $S \geq m/2 + m^2/4$.

□

Chapter 4

Tropical approach to legendrian curves in $\mathbb{C}P^3$

μνημόνευε οὖν πόθεν πέπτωκας καὶ μετανόησον καὶ τὰ πρῶτα ἔργα ποιήσον
εἰ δὲ μήτερομαί σοι καὶ κινήσω τὴν λυχνιαν σου ἐκ τοῦ τόπου αὐτῆς
ἐὰν μήμετανοήσης

Inspired by Gromov-Witten invariants, one can try to count holomorphic curves under some additional restrictions. We will see what can be said about counting of legendrian curves in $\mathbb{C}P^3$, passing through prescribed number of generic points and one generic line.

This problem was given to me by G. Mikhalkin, and previously mentioned by I. Vainsencher. His student, Édén Amorim [7] also studied the same question, but with different methods (localizations) and a bit different setup (he was looking for the number of rational legendrian curves through $2d+1$ generic lines). In fact, the goal was to enlarge tropical gear, conquest new territories like tropical differential forms, tropical distributions, etc. Finally, some combinatorial properties of tropical contact curves are found, but the mystery remains.

Below we summarize what is known about complex legendrian curves in $\mathbb{C}P^3$, and mention some related questions. However, in what follows we don't use these facts, our approach is completely elementary, if not only computational. We use Macaulay2 and Mathematica. The code is incorporated into this text, so the reader may verify the results.

The recent study of the *complex* legendrian curves (see also [2]), by itself, is motivated by minimal surfaces in four dimensional sphere¹. The map $(z_1, z_2, z_3, z_4) \rightarrow (z_1 + jz_2, z_3 + jz_4)$ from \mathbb{C}^4 to \mathbb{H}^2 yields so-called twistor (or Penrose) map $\phi : \mathbb{C}P^3 \rightarrow \mathbb{H}P^1 = S^4$, and Bryant has shown [34] that the images of the legendrian curves in $\mathbb{C}P^3$ under ϕ are superminimal surfaces in S^4 . Furthermore, each minimal immersion $S^2 \rightarrow S^4$ can be obtained as $\phi(C)$ where C is a rational legendrian curve in $\mathbb{C}P^3$. Then, each Riemann surface M can be mapped to a legendrian curve in $\mathbb{C}P^3$, using two meromorphic functions (f, g) on M . This proves that for each Riemann surface M^2 there exists a conformal minimal immersion $M^2 \rightarrow S^4$, and such immersions are nowadays constructed mostly by this approach².

The area of the image of a harmonic map $f : S^2 \rightarrow S^4$ equals $4\pi d$ if $f(S^2)$ comes as $\phi(C)$,

¹read [115] and [27] about minimal surfaces in \mathbb{R}^3 and S^3 , respectively.

²see also [164] about isometric deformation of minimal surfaces in S^4

where C is a legendrian rational curve in $\mathbb{C}P^3$ of degree d . The dimension of the space $\mathfrak{M}_{d,0}$ of legendrian maps $\mathbb{C}P^1 \rightarrow \mathbb{C}P^3$ of degree d is proven to be $2d + 4$ [24],[97],[161], [162] (and see [90] for the legendrian maps $\mathbb{C}P^1 \rightarrow \mathbb{C}P^{2n+1}$). This is done via studying the pairs of meromorphic function $(\frac{z_1}{z_2}, \frac{z_3}{z_4})$ of degree d with the same ramification divisor. Up to degree six the space $\mathfrak{M}_{d,0}$ is a smooth complex manifold [23], see a survey [79] and references therein about minimal immersions $S^2 \rightarrow S^{2n}$.

In [167](unpublished, see also [113]) it is proven that with $d \geq g + 3$ the part of the space $\mathfrak{M}_{d,g}$, which consists of smooth contact curves in $\mathbb{C}P^3$ of degree d and genus g , is smooth. Besides, it is proven there, that a complete intersection can not be a contact curve. That complicates the study of the surfaces of higher genus, which approached in [41], [42] [42]. In [98] it is proven that the dimension of $\mathfrak{M}_{d,g}$ is $2d - g + 4$ for $d \geq \max(2g, g + 2)$, and in [41] it is proven that the dimension of each irreducible component of $\mathfrak{M}_{d,g}$ is between $2d - 4g + 4$ and $2d - g + 4$, where upper bound is always attained by the totally geodesic immersions (whose image is in a line) and the lower bottom is obtained on $\mathfrak{M}_{6,1}$ and $\mathfrak{M}_{8g+1+3k,g}$. See [42], for further details about other possible pairs (d, g) with non-trivial contact curve. All this means that for $g \geq 1$ we need to take the degree d of the curve at least 6 what is now beyond our abilities to compute.

For a general overview of complex contact varieties and deformations of contact curves see [35], [167], [168]. Real algebraic contact structures are numerous, the questions about polynomial distributions went back to [69, 141], see Example 4.1.4.

For the works of the same spirit we mention the study of legendrian curves of minimal degree through two points with prescribed tangency [65] and contact curves in $PSL(2, \mathbb{C})$ [123].

For an introduction to tropical geometry see [29] and [32] and references therein. See also first few pages of Chapter 1 and introductions in Chapters 2,3.

4.1 The contact structure on $\mathbb{C}P^3$

Definition 4.1.1. A holomorphic form $\omega \in \Omega^1(\mathbb{C}P^3)$ is said to be a *contact form* if $\omega \wedge d\omega$ is nowhere zero.

Example 4.1.2. The form $\omega = ydx - xdy + wdz - zdw$ is contact.

Indeed, consider the restriction of ω to the chart $w = 1$. We have

$$\omega_{w=1} = u = dz + ydx - xdy, u \wedge du = -2dx \wedge dy \wedge dz \neq 0,$$

similar formulae hold in other charts.

Theorem 4.1.3 ([91]). Each contact holomorphic form ω on $\mathbb{C}P^3$ is of the type

$$(py - qz + aw)dx + (-px + rz + bw)dy + (qx - ry + cw)dz + (-ax - by - cz)dw \quad (4.1)$$

where a, b, c, p, q, r are constants and $pc + qb + ra \neq 0$. Furthermore, all such forms are equivalent under the $GL(4, \mathbb{C})$ action.

Proof. We only sketch the proof. Let α be a holomorphic contact form in $\mathbb{C}P^3$. The form $\alpha \wedge d\omega$ gives a section of the canonical bundle. Considering transition function for α we conclude that $c_1(\mathbb{C}P^3) = 2\alpha$. It means that if $Pdx + Qdy + Rdz$ is a contact form in the chart $w = 1$, then it

extends on the whole $\mathbb{C}P^3$ only if the transition function to another charts have w in denominator in degree at most 2. Therefore P, Q, R are polynomial of degree 1. The explicit form of all such polynomials that ω is contact follows from the direct computation. \square

On the other hand, there are many algebraic contact structures on $\mathbb{R}P^3$.

Example 4.1.4 (Numerous real algebraic contact forms). Consider $\omega' = (yz^2 + yw^2)dx + (-xz^2 - xw^2)dy + (x^2w + y^2w + w)dz + (-x^2z - y^2z - z)dw$, or $\omega(x^2y + y^3 + yz^2 + yw^2)dx - (x^3 + xy^2 + xz^2 + xw^2)dy + (x^2w + y^2w + z^2w + w^3)dz - (x^2z + y^2z + z^3 + zw^2)dw$. Then, a small perturbation of the coefficients of a real contact structure doesn't affect the fact $\omega \wedge d\omega \neq 0$, hence we can perturb the coefficients of ω' .

At the same time, it seems to be hard to enumerate real algebraic curves which are contact with respect to these contact structures.

Question 17. Does there exist a real algebraic contact form with all the coefficients of degree two?

Proposition 4.1.5. Any irreducible algebraic curve $C \in \mathbb{C}P^3$ of degree at least three is legendrian with at most one contact algebraic contact structure.

Indeed, when we intersect the distribution given by (4.1) with the distribution given by $\omega = yxd - xdy + wdz - zdw$, we obtain a vector field v almost everywhere (except finite collection of points as the code below shows). From the other hand, we know that there is a line, tangent to the obtained distribution, through each point in $\mathbb{C}P^3$. Therefore the integral curves for v are lines almost everywhere. Hence, the only locus where a curve, tangent to both distribution, can leave, is the set where these two contact forms coincide, i.e. a finite collection of points.

```
use QQ[p,q,r,a,b,c,x,y,z,w]
a1=p*y-q*z+a*w
a2=-p*x+r*z+b*w
a3=q*x-r*y+c*w
a4=-a*x-b*y-c*z

I=ideal(a1*x-a2*y, a2*w-a3*x,a3*z-a4*w)
C=minimalPrimes I
J=C_8 --all the other ideals C_0,C_1,... give lines if we fix a,b,c,p,q,r
dim J ==1, so it is just a collection of points.
```

The global Reeb vector field for the contact structure $\omega = ydx - xdy + wdz - zdw$ is given by $y\frac{\partial}{\partial x} - x\frac{\partial}{\partial y} + w\frac{\partial}{\partial z} - z\frac{\partial}{\partial w}$. Its trajectories (i.e. the fibers of the Penrose map) are

$$\varphi(t) = \left(A\frac{(t^2 - 1)}{(t^2 + 1)}, 2A\frac{t}{(t^2 + 1)}, B\frac{((t + k)^2 - 1)}{((t + k)^2 + 1)}, 2B\frac{(t + k)}{((t + k)^2 + 1)} \right) \quad (4.2)$$

and $(\frac{t^2-1}{t^2+1})' = \frac{4t}{t^2+1}, (\frac{2t}{t^2+1})' = \frac{t^2-1}{t^2+1}$. So, the Reeb vector field just rotates in xy plane and zw plane on the same angle. For each fixed angle this gives a linear transformation.

4.1.1 Contact form automorphisms

It is known that the group of automorphisms of $\mathbb{C}P^3$ which preserve the form $\omega = ydx - xdy + wdz - zdw$ is³ the symplectic group $Sp(4, \mathbb{C})$. The dimension count gives $\dim Sp(4, \mathbb{C}) = 10$ and $\dim PGL(4, \mathbb{C}) = 15$, what agrees with the fact the set of all contact structures ((4.1)) is five-dimensional.

Proposition 4.1.6. We list the set of generators of this group $Sp(4, \mathbb{C})$.

$$\begin{aligned}
 \bullet 1) \ x \rightarrow x + \lambda y, & \begin{pmatrix} 1 & \lambda & 0 & 0 \\ 0 & 1 & 0 & 0 \\ 0 & 0 & 1 & 0 \\ 0 & 0 & 0 & 1 \end{pmatrix} & \bullet 3) \ x \rightarrow z, y \rightarrow w, & \begin{pmatrix} 0 & 0 & 1 & 0 \\ 0 & 0 & 0 & 1 \\ 1 & 0 & 0 & 0 \\ 0 & 1 & 0 & 0 \end{pmatrix} \\
 \bullet 2) \ x \rightarrow y, y \rightarrow -x, & \begin{pmatrix} 0 & 1 & 0 & 0 \\ -1 & 0 & 0 & 0 \\ 0 & 0 & 1 & 0 \\ 0 & 0 & 0 & 1 \end{pmatrix} & \bullet 4) \ x \rightarrow x + \lambda w, z \rightarrow z + \lambda y, & \begin{pmatrix} 1 & 0 & 0 & \lambda \\ 0 & 1 & 0 & 0 \\ 0 & \lambda & 1 & 0 \\ 0 & 0 & 0 & 1 \end{pmatrix} \\
 \bullet 5) \ x \rightarrow \lambda x, y \rightarrow y/\lambda, & \begin{pmatrix} \lambda & 0 & 0 & 0 \\ 0 & 1/\lambda & 0 & 0 \\ 0 & 0 & 1 & 0 \\ 0 & 0 & 0 & 1 \end{pmatrix} & &
 \end{aligned}$$

Proposition 4.1.7. The restriction of a contact structure (4.1) on a plane $z = w = 0$ is $pydx - px dy = 0$ by an easy computations.

Therefore the vector field, generated by the contact form, at a point (x, y) equals x, y , so the only integral curves are the lines passing through the origin. Since all the planes are equivalent under the action of $GL(4, \mathbb{C})$, all the planar contact curves are collections of lines.

Let us choose an arbitrary plane L .

Proposition 4.1.8. Each contact curve in L is a collection of lines through a point $p \in L$. Moreover, L is the contact plane at p , i.e. L is the zero set of ω computed at p .

4.1.2 Macaulay2 code for the action of contactomorphism group on triplets of points

Proposition 4.1.9. All the elements of $Sp(4, \mathbb{C})$ which preserve $(0, 0, 0, 1), (1, 1, 1, 1), (-1, 1, -1, 1)$ are of the form

$$\text{Stab}_\mu^3 : x \rightarrow x, y \rightarrow y + \mu(z - x), z \rightarrow z, w \rightarrow w - \mu(z - x), \begin{pmatrix} 1 & 0 & 0 & 0 \\ -\mu & 1 & \mu & 0 \\ 0 & 0 & 1 & 0 \\ \mu & 0 & \mu & 1 \end{pmatrix} \quad (4.3)$$

³We have 6 conditions on the coefficients of a matrix $A \in GL(4, \mathbb{C})$, since A preserves ω and conditions $\det A \neq 0$, but one can check (by Macaulay2 for example), that the set of such $A \subset \mathbb{C}^{16}$ is a quasiprojective variety of dimension 10.

Proof. Direct calculation. □

It is easy to bring any point of $\mathbb{C}P^3$ to $(0, 0, 0, 1)$ by an element of $\mathrm{Sp}(4)$. Then, points of $\mathbb{C}P^3$ can be divided in two classes: those, lying on the plane L through $(0, 0, 0, 1)$ such that $\omega((0, 0, 0, 1))|_L = 0$ and all the others. The subgroup of $\mathrm{Sp}(4)$, stabilizing $(0, 0, 0, 1)$ acts on both these classes transitively. Now, consider a point p which is not on the contact planes through $(0, 0, 0, 1)$ and $(1, 1, 1, 1)$. We prove that there is an element in the subgroup of $\mathrm{Sp}(4)$ stabilizing $(0, 0, 0, 1)$ and $(1, 1, 1, 1)$ that sends p to $(-1, 1, -1, 1)$.

Lemma 4.1.10. The group $\mathrm{Sp}(4)$ is *generically 3-transitive*, i.e. every three points $p_1, p_2, p_3 \in \mathbb{C}P^3$ in general position can be sent to every three points $q_1, q_2, q_3 \in \mathbb{C}P^3$ in general position by an element $a \in \mathrm{Sp}(4, \mathbb{C})$. In general, the set $\{a \in \mathrm{Sp}(4) | a(p_i) = q_i, i = 1, 2, 3\}$ is of dimension one.

The following code in Macaulay2 produces a matrix preserving the contact form ω , which brings generic points $(a_1, b_1, c_1, 1), (a_2, b_2, c_2, 1), (a_3, b_3, c_3, 1)$ to $(0, 0, 0, 1), (1, 1, 1, 1)$ and $(-1, 1, -1, 1)$. The group of contactomorphisms is generated by the matrices A, B, C, D (see Proposition 4.1.6 and below formulae) and by straightforward combination of them we arrive to the answer.

```
--generators of the contactomorphism group Sp(4,C),
-- their action on a matrix M
-- x->x+lambda y
A=(lambda,M)->(matrix{{1,lambda,0,0},{0,1,0,0},{0,0,1,0},{0,0,0,1}}*M)
--x->y,y->-x
B=M->(matrix{{0,-1,0,0},{1,0,0,0},{0,0,1,0},{0,0,0,1}}*M)
--x<->z,y<->w
C=M->(matrix{{0,0,1,0},{0,0,0,1},{1,0,0,0},{0,1,0,0}}*M)
--x->x+ lambda w, z-> z+lambda y
D=(lambda,M)->
(matrix{{1,0,0,lambda},{0,1,0,0},{0,lambda,1,0},{0,0,0,1}}*M)

--special contactomorphism, which preserve (0,0,0,1),(1,1,1,1)
--and brings (x,y,z,w) to (-1,1,-1,1)
Q=QQ[x,y,z,w];
c:=(x-y+z-w)/(4*z);
a:=- (y+z)/(2*z);
b:=(-x+y+z-w)/(2*(y-z));
M:=matrix{{a+1,b+c-a+a*b-1,-b*(a+1),0},
{a,c+a*(b-1),-b*a,0},{0,0,c,0},{0,b,c-1-b,1}};
M0:=inverse(M);
den:= denominator M0_(0,0);
M0=den*M0;
M0=lift(M0,Q);

--this function gives the matrix for the contactomorphism which
```



```

--brings (a1,b1,c1,1),(a2,b2,c2,1),(a3,b3,c3,1) to
-- (0,0,0,1),(1,1,1,1) and (-1,1,-1,1)
transformation = (a1,b1,c1,a2,b2,c2,a3,b3,c3,R)->(
  use R;
  T1:=matrix{{a1,a2,a3},{b1,b2,b3},{c1,c2,c3},{1,1,1}};
  T2:=C(T1);
  lambda1 := -(entries(T2)_0)_0;
  T3:=C(A(lambda1,T2));
  lambda2:=- (entries(T3)_0)_0/(entries(T3)_0)_1;
  T4:=B(A(lambda2,T3));
  lambda3:=- (entries(T4)_0)_0/(entries(T4)_0)_3;
  T5:=D(lambda3,T4);
  T6:=B(C(T5));
  lambda4 :=-((entries(T6)_1)_0 + (entries(T6)_1)_1)/(entries(T6)_1)_1;
  T7:=C(B(A(lambda4,T6)));
  lambda5 := ((entries(T7)_1)_2-(entries(T7)_1)_0)/(entries(T7)_1)_1;
  T8:=B(A(lambda5,T7));
  lambda6 := ((entries(T8)_1)_2-(entries(T8)_1)_0)/(entries(T8)_1)_1;
  T9:=A(lambda6,T8);
  den:=denominator T9_(0,2);
  T9=den*T9;
  T9=lift(T9,R);
  (p1,p2,p3,p4):=((entries(T9)_2)_0,(entries(T9)_2)_1,
  (entries(T9)_2)_2,(entries(T9)_2)_3);
  M1:=sub(M0,{x=>p1,y=>p2,z=>p3,w=>p4});
  revers:=XX->(
    YY:=A(-lambda4,B(B(B(C(A(-lambda5,B(B(B(A(-lambda6,(M1*XX))))))))));
    C(A(-lambda1,C(A(-lambda2,B(B(B(D(-lambda3,C(B(B(B(YY)))))))))))));
  );
  SR:=revers(matrix{{1,0,0,0},{0,1,0,0},{0,0,1,0},{0,0,0,1}});
  SR=lift(SR,R);
  SR)

```

4.1.3 Curves on a hypersurface of degree two

Consider a contact form ω as in (4.1). We are going to find the restriction of ω on the surface X , given by

$$\{xy - zw = 0\} = \text{Im}(f: \mathbb{C}P^1 \times \mathbb{C}P^1 \rightarrow \mathbb{C}P^3), f: (\mu : \mu'), (\nu : \nu') \rightarrow (\mu\nu', \mu'\nu, \mu\nu, \mu'\nu'). \quad (4.4)$$

Note, that any irreducible hypersurface X' of degree 2 in $\mathbb{C}P^3$ is projectively equivalent to X , therefore in this way we will describe all the legendrian curves on all the non-degenerate hypersurfaces X' of degree 2.

Computing in the affine chart $(\mu, \nu, \mu\nu, 1)$, we obtain

$$f_* : \frac{\partial}{\partial \mu} \rightarrow \frac{\partial}{\partial x} + y \frac{\partial}{\partial z}, \frac{\partial}{\partial \nu} \rightarrow \frac{\partial}{\partial y} + x \frac{\partial}{\partial z}.$$

The fact that $\omega(f_*(M \frac{\partial}{\partial \mu} + N \frac{\partial}{\partial \nu})) = 0$ at $(\mu, \nu, \mu\nu, 1)$ is equivalent to

$$(p\nu - q\mu\nu + a)M + (-p\mu + r\mu\nu + b)N + (q\mu - r\nu + c)(M\nu + N\mu) = 0, \text{ i.e.}$$

$$M(p\nu + a - r\nu^2 + c\nu) + N(-p\mu + b + q\mu^2 + c\mu) = 0.$$

If a curve is of type $(\mu(t), \nu(t))$ locally, then its tangent vector is given by the formula $\mu' \frac{\partial}{\partial \mu} + \nu' \frac{\partial}{\partial \nu}$. But this, after reparametrization, means that

$$\frac{d\mu}{dt} = (c - p)\mu + b + q\mu^2, \frac{d\nu}{dt} = -((p + c)\nu + a - r\nu^2). \quad (4.5)$$

We are looking for the algebraic leafs of this foliation. See [60, 159] about space of foliations with algebraic leafs, [11] for the classification of the quadratic systems with the first integral.

Example 4.1.11. Consider the curve $(t, t^2, t^3, 1)$ which lies on the hypersurface $\{xy - zw = 0\}$. It is legendrian with respect to the form $3dx - 3dy + wdz - zdw = 0$ so we put $p = 3, c = 1, q = a = r = b = 0$ and (4.5) becomes $(\mu', \nu') = (-2\mu, -4\nu) = (\mu, 2\nu)$, hence $\mu = e^t, \nu = e^{2t}$ which is the same as $(\mu, \nu) = (t, t^2)$, and subsequently $\mu\nu = t^3$.

Depending on the coefficients, each equation $\frac{dx}{dt} = c_0 + c_1x + c_2x^2$ after a linear change of the coordinates (over complex numbers) becomes one in the following list:

- $\frac{dx}{dt} = c,$
- $\frac{dx}{dt} = cx,$
- $\frac{dx}{dt} = cx^2,$
- $\frac{dx}{dt} = c(x^2 - 1).$

Example 4.1.12. If $\frac{d\mu}{dt} = c_0(\mu^2 - 1), \frac{d\nu}{dt} = c_1(\nu^2 - 1)$, then $\frac{d\mu}{\mu^2 - 1} = c_3 \frac{d\nu}{\nu^2 - 1}$. That implies $\log(\frac{\mu-1}{\mu+1}) = c_4 \log(\frac{\nu-1}{\nu+1}) + c_5$, and finally $c_6(\frac{\nu-1}{\nu+1}) = c_7(\frac{\mu-1}{\mu+1})^{d_1}$ which is algebraic if $d_1 \in \mathbb{Q}$.

To the contrary, the case $\frac{d\mu}{dt} = c_0(\mu^2 - 1), \frac{d\nu}{dt} = c_1\nu^2$ always gives a non-algebraic curve if $c_0c_1 \neq 0$ because this gives an equation of the type $\frac{\mu-1}{\mu+1} = e^{1/\nu}$.

Theorem 4.1.13. After a linear change of coordinates $\tilde{\mu} = c_0 + c_1\mu, \tilde{\nu} = c_2 + c_3\nu$ any the legendrian curve on the quadric $xy - zw = 0$ with parametrization (4.4) can be written in one of the following standard forms :

- $c_0(\frac{\nu-1}{\nu+1})^{d_1} = c_1(\frac{\mu-1}{\mu+1})^{d_2},$
- $c_0\nu^{d_1} = c_1\mu^{d_2},$

- $c_0\left(\frac{\nu-1}{\nu+1}\right)^{d_1} = c_1\mu^{d_2}$,
- $c_0\left(\frac{\mu-1}{\mu+1}\right)^{d_1} = c_1\nu^{d_2}$,
- $c_0\mu\nu + c_1\mu + c_2\nu = 0$,
- $c_0\mu + c_1\nu + c_2 = 0$,
- $c_0\mu\nu + c_1\mu + c_2 = 0$,
- $c_0\mu\nu + c_1\nu + c_2 = 0$,
- $\mu = c_0$,
- $\nu = c_0$,

where $c_i \in \mathbb{C}$, $d_i \in \mathbb{N}_0$ are some constants.

Question 18. Given that classification one might count the legendrian curves of given degree and genus lying in a quadric. For example, all rational quartics lie on a quadric surface. So we can count them.

4.1.4 Legendrian curves of degrees one and two

Definition 4.1.14. A map $f : M \rightarrow \mathbb{C}P^3$ is *totally geodesic* if $f(M)$ is a legendrian line.

Let us study the rational legendrian curves of degrees one and two. In the case $\deg x, y, z = 1$ or 2, it happens that curve is parametrized by $(f, p + qf, r + pf)$, where f is a polynomial degree 1 or 2.

Consider a general line $l = (a_0 + b_0s, a_1 + b_1s, a_2 + b_2s, a_3 + b_3s)$ in $\mathbb{C}P^3$. Putting it into the contact form we conclude that the line l is legendrian iff $a_1b_0 - a_0b_1 + a_3b_2 - a_2b_3 = 0$.

It means that for a point A we have 1-dimensional family of legendrian lines through A , this family is just a plane.

Therefore the number of legendrian lines through 1 point and 1 line equals 1.

Let's observe one important property of legendrian lines. One can think about a line l in $\mathbb{C}P^3$ as four section x, y, z, w of $\mathcal{O}(1)$ on $\mathbb{C}P^1$. Let X, Y, Z, W be the roots of x, y, z, w , $x = a_0 + b_0s$, $X = -\frac{a_0}{b_0}$, $y = a_1 + b_1s$, etc.

Proposition 4.1.15. The following three conditions are equivalent:

- the line l is legendrian,
- $y(X)/z(X) = w(Z)/x(Z)$,
- $x(Y)/w(Y) = z(W)/y(W)$.

Proof. Look at table with values of x, y, z, w in X, Y, Z, W .

$$\begin{pmatrix} X = & (0, & \frac{a_1b_0-b_1a_0}{b_0}, & \frac{a_2b_0-b_2a_0}{b_0}, & \frac{a_3b_0-b_3a_0}{b_0}) \\ Y = & (\frac{a_0b_1-a_1b_0}{b_1}, & 0, & \frac{a_2b_1-a_1b_2}{b_1}, & \frac{a_3b_1-a_1b_3}{b_1}) \\ Z = & (\frac{a_0b_2-a_2b_0}{b_2}, & \frac{a_1b_2-a_2b_1}{b_2}, & 0, & \frac{a_3b_2-a_2b_3}{b_2}) \\ W = & (\frac{a_0b_3-a_3b_0}{b_3}, & \frac{a_1b_3-a_3b_1}{b_3}, & \frac{a_2b_3-a_3b_2}{b_3}, & 0) \end{pmatrix}$$

□

Question 19. Is it possible to generalize this theorem for the curves of higher degree? As we see in Example 4.2.6, the straightforward generalization is not true.

4.1.5 Legendrian cubics via Macaulay2

```
clearAll
--coefficients of the parametrisation of the cubic
mainvar=(a0,a1,a2,a3,b0,b1,b2,b3,c0,c1,c2,c3,d0,d1,d2,d3)
R=QQ[mainvar]
P=R[s]
--polynomials for each coordinate
x=a0+a1*s+a2*s*s+a3*s*s*s
y=b0+b1*s+b2*s*s+b3*s*s*s
z=c0+c1*s+c2*s*s+c3*s*s*s
t=d0+d1*s+d2*s*s+d3*s*s*s

cont = y*dif(s,x)-x*dif(s,y)+t*dif(s,z)-z*dif(s,t)
--in M we have our relation for variables since in cont (as a polynomial in z) all the coef. sh
(C,M) = coefficients cont
(A,B,C)=(0,1,-1)

xA=sub(x,{s=>A})
xB=sub(x,{s=>B})
xC=sub(x,{s=>C})

yA=sub(y,{s=>A})
yB=sub(y,{s=>B})
yC=sub(y,{s=>C})

zA=sub(z,{s=>A})
zB=sub(z,{s=>B})
zC=sub(z,{s=>C})

tA=sub(t,{s=>A})
tB=sub(t,{s=>B})
tC=sub(t,{s=>C})
```

```

--choose kind of random points
(p11,p12,p13,p14)=(29,-6,13,11)
(p21,p22,p23,p24)=(-3,-17,7,-5)
(p31,p32,p33,p34)=(16,-5,6,23)
--conditions that our curve passes through chosen points
(i1,i2,i3)=(p14*xA-p11*tA,p14*yA-p12*tA,p14*zA-p13*tA)
(j1,j2,j3)=(p24*xB-p21*tB,p24*yB-p22*tB,p24*zB-p23*tB)
(k1,k2,k3)=(p34*xC-p31*tC,p34*yC-p32*tC,p34*zC-p33*tC)

use R
N= M_0
l=i->lift(i,R)

J = ideal(i1,i2,i3,l(N_0),l(N_1),l(N_2),l(N_3),l(N_4))
S = minimalPrimes J
J0 = S_0
J1 = S_1
J2 = S_2
--S_3 does not exist

di=i->dim variety i
use P
Null = ideal(x,y,z,t) --if Null is a subset of our ideal,
-- it means that x,y,z,t are all zeroes at some point,
-- so we are not interested in such coefficients a0,a1, ...

di J0 -- 7
di J1 -- 8 that raise our suspicions...
di J2 -- 7

--ideal(s-A) means evaluation at A
isSubset(Null, promote(J0,P)+ideal(s-A)) -- false,
isSubset(Null, promote(J1,P)+ideal(s-A)) --true, eliminate!
isSubset(Null, promote(J2,P)+ideal(s-A)) --false

use R
S0 = minimalPrimes (J0+ideal(j1,j2,j3))
J00=S0_0
J01=S0_1
--S0_2 do not exist

use P
isSubset(Null, promote(J00,P)+ideal(s-B)) --false

```

```

isSubset(Null, promote(J01,P)+ideal(s-B))--true! eliminate

use R
S01 = minimalPrimes (J00+ideal(k1,k2,k3))
J000=S01_0
J001=S01_1

use P
isSubset(Null, promote(J000,P)+ideal(s-C)) --false
isSubset(Null, promote(J001,P)+ideal(s-C)) --true eliminate

di J000--1
degree J000--1, so it is linear!
-----
S2 = minimalPrimes (J2 + ideal(j1,j2,j3))
J20=S2_0
--S2_1 does not exist

isSubset(Null, promote(J20,P)+ideal(s-B)) --true, eliminate!

```

As we see, we impose all the constrains on the coefficients a_i, b_i, c_i, d_i and found that the subvariety of the coefficients of legendrian cubics through three generic points is of dimension one (as expected) and of degree one (it was not expected).

4.1.6 Legendrian cubics

Any rational non-planar cubic is equivalent to $(t, t^2, t^3, 1)$. We can choose a contact form ω_1 such that $(t, t^2, t^3, 1)$ was legendrian with respect to it.

Lemma 4.1.16. The cubic $(t, t^2, t^3, 1)$ is legendrian with respect to only one contact structure $\omega_1 = 3ydx - 3xdy + wdz - zdw$.

Proof. Direct calculation, using (4.1). □

We fix the contact form w_1 , then by a contactomorphism we can bring any three generic points to $(0, 0, 0, 1), (1, 1, 1, 1), (-1, 1, -1, 1)$. The main result of this section is the following theorem (in the previous Section we already predicted that the family of such curves should be parametrized by a line).

Theorem 4.1.17. All the rational cubics passing through $(0, 0, 0, 1), (1, 1, 1, 1), (-1, 1, -1, 1)$ and tangent to $\omega_1 = 3ydx - 3xdy + wdz - zdw$ are of the form

$$l(t, \mu) = (t, t^2 + \mu(t - t^3), t^3, 1 - 3\mu(t - t^3)). \quad (4.6)$$

The result of the theorem is not surprising. We have the orbit of the action of Stab_μ^3 (see 4.3) on $(t, t^2, t^3, 1)$. Therefore, the only problem is to show that there are no other solutions.

Corollary 4.1.18. For each complex contact form on $\mathbb{C}P^3$ the number of contact rational cubics through three generic points and a line in general position is equal to three.

Proof. We intersect the family (4.6) with a generic line L of the type $(t', p_1 + q_1t', p_2 + q_2t', p_3 + q_3t')$. Because of the genericity, L does not pass through $(0, 0, 0, 1) = l(0, \mu)$, therefore we may suppose that at any intersection of L and $l(t, \mu)$ we have $t \neq 0$. Therefore, at a point of intersection we have $t' = ct$ for some c , and then

$$p_1 + q_1t' = c(t^2 + \mu(t - t^3)), p_2 + q_2t' = ct^3, p_3 + q_3t' = c(1 - 3\mu(t - t^3)). \quad (4.7)$$

We have $3(p_1 + q_1t') + p_3 + q_3t' = c(3t^2 + 1)$, therefore, substituting $t' = ct$ we obtain $c = \frac{3p_1 + p_3}{3t^2 - 3q_1t - q_3t + 1}$. Then, using the first equality in (4.7), we get $\mu = \frac{p_1 + q_1ct - ct^2}{c(t - t^3)}$. Then, since $c(t^3 - q_2t) = p_2$, we have $t^3 - q_2t = \frac{p_2}{3p_1 + p_3}(3t^2 - 3q_1t - q_3t + 1)$. Choosing p_2, q_2 appropriately, we see that the last equation usually has three roots. \square

Proof of Theorem 4.1.17. Each rational cubic curve has a parametrization of the form

$$(a_0 + a_1t + a_2t^2 + a_3t^3, b_0 + b_1t + b_2t^2 + b_3t^3, c_0 + c_1t + c_2t^2 + c_3t^3, d_0 + d_1t + d_2t^2 + d_3t^3).$$

We may suppose that our cubic passes through points $(0, 0, 0, 1), (1, 1, 1, 1), (-1, 1, -1, 1)$ at $t = 0, 1, -1$ respectively. Substituting $t = 0$ in the parametrization, we obtain $a_0 = b_0 = c_0 = 0, d_0 = 1$. Substitutions $t = \pm 1$ give us

$$\begin{aligned} a_1 + a_2 + a_3 &= b_1 + b_2 + b_3 = c_1 + c_2 + c_3 = 1 + d_1 + d_2 + d_3, \\ a_1 - a_2 + a_3 &= -b_1 + b_2 - b_3 = c_1 - c_2 + c_3 = 1 - d_1 + d_2 - d_3. \end{aligned}$$

Therefore, $a_2 = b_1 + b_3 = c_2 = d_1 + d_3, a_1 + a_3 = b_2 = c_1 + c_3 = 1 + d_2$.

Substituting indeterminates with bigger indices as functions of the indeterminates with smaller indices we obtain that our curve is parametrized by

$$(a_1t + a_2t^2 + (b_2 - a_1)t^3, b_1t + b_2t^2 + (a_2 - b_1)t^3, c_1t + a_2t^2 + (b_2 - c_1)t^3, 1 + d_1t + (b_2 - 1)t^2 + (a_2 - d_1)t^3).$$

Evaluate the form $3ydx - 3xdy + wdz - zdw$ on the curve we obtain

$$\begin{aligned} &3(b_1t + b_2t^2 + (a_2 - b_1)t^3)(a_1 + 2a_2t + 3(b_2 - a_1)t^2) - 3(a_1t + a_2t^2 + (b_2 - a_1)t^3)(b_1 + 2b_2t + 3(a_2 - b_1)t^2) + \\ &(1 + d_1t + (b_2 - 1)t^2 + (a_2 - d_1)t^3)(c_1 + 2a_2t + 3(b_2 - c_1)t^2) - \\ &(c_1t + a_2t^2 + (b_2 - c_1)t^3)(d_1 + 2(b_2 - 1)t + 3(a_2 - d_1)t^2) = 0. \end{aligned}$$

The coefficient before t^0 should be equal to 0, so $c_1 = 0$. The parametrization rewrites as

$$\begin{aligned} &3(b_1t + b_2t^2 + (a_2 - b_1)t^3)(a_1 + 2a_2t + 3(b_2 - a_1)t^2) - 3(a_1t + a_2t^2 + (b_2 - a_1)t^3)(b_1 + 2b_2t + 3(a_2 - b_1)t^2) + \\ &(1 + d_1t + (b_2 - 1)t^2 + (a_2 - d_1)t^3)(2a_2t + 3b_2t^2) - (a_2t^2 + b_2t^3)(d_1 + 2(b_2 - 1)t + 3(a_2 - d_1)t^2) = 0. \end{aligned}$$

Coefficient before t^1 equals $2a_2$, so $a_2 = 0$.

$$\begin{aligned}
& 3(b_1t + b_2t^2 - b_1t^3)(a_1 + 3(b_2 - a_1)t^2) - 3(a_1t + (b_2 - a_1)t^3)(b_1 + 2b_2t - 3b_1t^2) + \\
& \quad (1 + d_1t + (b_2 - 1)t^2 - d_1t^3)(3b_2t^2) - (b_2t^3)(d_1 + 2(b_2 - 1)t - 3d_1t^2) = \\
& 3(b_1t + b_2t^2 - b_1t^3)(a_1 + 3(b_2 - a_1)t^2) - 3(a_1t + (b_2 - a_1)t^3)(b_1 + 2b_2t - 3b_1t^2) + \\
& \quad b_2t^2(3 + 3d_1t + 3(b_2 - 1)t^2 - 3d_1t^3 - d_1t - 2(b_2 - 1)t^2 + 3d_1t^3) = \\
& 3(b_1t - b_1t^3)(a_1 + 3(b_2 - a_1)t^2) - 3(a_1t + (b_2 - a_1)t^3)(b_1 - 3b_1t^2) + \\
& \quad b_2t^2(3(b_2 - a_1)t^2 - 3a_1 + 3 + 2d_1t + (b_2 - 1)t^2) = \\
& b_1t^3(-3a_1 - 9(b_2 - a_1)t^2 + 9(b_2 - a_1) + 9a_1 - 3(b_2 - a_1) + 9(b_2 - a_1)t^2) + b_1t(3a_1 - 3a_1) + \\
& \quad b_2t^2(3(b_2 - a_1)t^2 - 3a_1 + 3 + 2d_1t + (b_2 - 1)t^2) = \\
& 6b_1b_2t^3 + b_2t^2(3(b_2 - a_1)t^2 - 3a_1 + 3 + 2d_1t + (b_2 - 1)t^2) = \\
& b_2t^2(6b_1t + 3(b_2 - a_1)t^2 - 3a_1 + 3 + 2d_1t + (b_2 - 1)t^2) = \\
& b_2t^2(t(6b_1 + 2d_1) + t^2(4b_2 - 3a_1 - 1) - 3a_1 + 3) = 0
\end{aligned}$$

Therefore, either $b_2 = 0$ or $a_1 = 1, b_2 = 1, d_1 = -3b_1$.

In the first case the curve is going to be like

$$(a_1t - a_1t^3, b_1t - b_1t^3, 0, 1 + d_1t - t^2 - d_1t^3) = (a_1t, b_1t, 0, 1 + d_1t).$$

what is not really a cubic, but in the second case we have

$$(t, b_1t + t^2 - b_1t^3, t^3, 1 - 3b_1t + 3b_1t^3) = (t, t^2 + \mu(t - t^3), t^3, 1 - 3\mu(t - t^3)).$$

As we predicted in the previous Section, we obtained a linear family of cubics. \square

Remark 4.1.19. One can look at what happens in the limiting case $\mu = \infty$. The family of curves converges to a point $(0, -1/3, 0)$. From the other hand their tangent vectors at $t = 0, 1, -1$ converge to $(0, 1, 0), (-3, -4, -3), (3, -4, 3)$ respectively. So, contact lines from $(0, 0, 0, 1), (1, 1, 1, 1), (-1, 1, -1, 1)$ with these tangent vectors all intersect in $(0, -1/3, 0)$. So, this family converges to these three lines, these three lines with the embedded point $(0, -1/3, 0)$ is a point on the boundary of the Hilbert scheme of rational cubics in $\mathbb{C}P^3$ (see [136] for more details about the compactification of the space of rational cubics).

Question 20. If it is true for higher degree? The hypothesis is that it is always d legendrian rational curves of degree d pass through d generic points and a line. Indeed, we take the one dimensional family of the degree d legendrian curves through d points in a plane L and write the equation of the surface that they sweep. Then we intersect this surface with L . We obtain a collection of d lines in the intersection, therefore the degree of the surface is at least d , therefore there is at least d legendrian curves through d generic points and one generic line. Also, this approach works for any genus, as long as the set of the curves is not empty.

4.1.7 Cubic surface containing the family of legendrian cubics

Here we find the equation of the surface containing all the cubics in the previous subsection. The equation of this surface is $F(x, y, z, w) = 2x^3 + 21x^2z - 27y^2z - 54yzw - 27zw^2 + 60xz^2 + 25z^3$. Such a surface intersects a generic line in three points, this gives another proof of Corollary 4.1.18.

We found the family of legendrian cubics through $(0, 0, 0, 1)$, $(1, 1, 1, 1)$, $(-1, 1, -1, 1)$ and tangent to $\omega_1 = 3ydx - 3xdy + wdz - zdw$. Therefore the family $(3t, t^2 + \mu(t - t^3), t^3, 1 - 3\mu(t - t^3))$ is tangent to $\omega = ydx - xdy + wdz - zdw$ but passes through $(0, 0, 0, 1)$, $(3, 1, 1, 1)$, $(-3, 1, -1, 1)$. Therefore we apply the contactomorphism

$$\psi = \begin{pmatrix} 1/2 & 0 & -1/2 & 0 \\ 0 & 1 & 0 & 0 \\ 0 & 0 & 1 & 0 \\ 0 & 1/2 & 0 & 1/2 \end{pmatrix}$$

which brings these three points to the standard ones.

After the action of ψ the parametrization of the family of legendrian rational cubics through $(0, 0, 0, 1)$, $(1, 1, 1, 1)$, $(-1, 1, -1, 1)$ is

$$(3t - t^3, 2t^2 + 2\mu(t - t^3), 2t^3, 1 + t^2 - 2\mu(t - t^3)). \quad (4.8)$$

In the following computation we choose the affine coordinates $(x/z, y/z, 1, w/z)$.

```
R=QQ[x,y,w]
T=QQ[t,m]
cubic = {(3*t^2-1)/(2), (2*t^1+2*m*(t^2-1))/(2), (t^3+t^1-2*m*(t^2-1))/(2)}
--isContact(-t^3+3*t, 2*t^2+2*m*(t-t^3), 2*t^3, t^2+1 - 2*m*(t-t^3), t)
f=map(T,R,cubic)
I=ker f
l=mingens I
g=l_0_0 -- 2x^3+21x^2-27y^2-54yw-27w^2+60x+25
R=QQ[x,y,z,w]
g1=2*x^3+21*x^2*z-27*y^2*z-54*y*z*w-27*z*w^2+60*x*z^2+25*z^3
g1-g ==0
sub(g1, {x=>3*t-t^3, y=>2*t^2+2*m*(t-t^3), z=>2*t^3, w=>1+t^2-2*m*(t-t^3)})
sub(g1, {x=>0, y=>0, z=>0, w=>1}) ==0
sub(g1, {x=>1, y=>1, z=>1, w=>1}) ==0
sub(g1, {x=>-1, y=>1, z=>-1, w=>1}) ==0

-- surface containing all legendrian cubics through (0,0,0,1), (1,1,1,1), (-1,1,-1,1)
cubicSurface=(x,y,z,w)->(-2*x^3-21*x^2*z+27*y^2*z-60*x*z^2-25*z^3+54*y*z*w+27*z*w^2)

--check if the functions x(s),y(s),...give a contact curve
isContact = (x,y,z,w,s)->
(
  a:= y*diff(s,x)-x*diff(s,y)+w*diff(s,z)-z*diff(s,w)
)
```

4.2 Tropicalization of legendrian curves

In what follows we suppose that small letters stand for complex numbers of complex-valued functions of t . By the same big letters we denote the corresponding limit of \log_t . For example, $\lim_{t \rightarrow \infty} \log_t a(t) = A$. We do not specify each time whether a small letter stands for a function or is a complex number, because it is clear from the context.

Definition 4.2.1. A tropical curve $C \subset \mathbb{TP}^3$ is a tropical legendrian curve if there is a family $C_t \subset \mathbb{CP}^3$ of complex legendrian curves, such that $\lim_{t \rightarrow \infty} \log_t(C_t) = C$ in the Hausdorff sense.

Now we state the problem: given three points $P_1, P_2, P_3 \in \mathbb{TP}^3$ in general position, we want to describe the family $S(P_1, P_2, P_3)$ of tropic legendrian cubics through them.

Proposition 4.2.2. The problem is correct in the sense that the set of the tropicalizations of the legendrian curves through generic liftings of P_1, P_2, P_3 to the families of points p_1^t, p_2^t, p_3^t such that $\lim_{t \rightarrow \infty} \log_t(p_i^t) = P_i$ coincide.

Proof. Indeed, a small change of points p_1, p_2, p_3 to p_1', p_2', p_3' affects $S_t(p_1, p_2, p_3)$ only a few, because we can apply the contactomorphism which brings p_1, p_2, p_3 to p_1', p_2', p_3' , and since we found its form, we see that its matrix is close to the identity matrix. That finishes the proof. \square

Similar statements are valid in general situation. If we consider some family of complex curves, then the dimension of the deformation space of a generic curve in this family coincides with the dimension of the deformation space of a generic tropical curve in the corresponding family of tropical curves. From the other hand, if a generic complex curve is superabundant, the same is true for the corresponding tropical curves. Another argument could be that the family of legendrian curves through three points sweeps a cubic surfaces, and we can look at the tropicalization of this surface.

4.2.1 Tropical legendrian lines

Consider a tropical legendrian line L , i.e. L is the limit of legendrian complex lines l_t .

Equations in Proposition 4.1.15 survive under tropical limit, and in the same notation but in the tropical situation we have $y(X) + x(Z) + x(Y) + y(W) = z(X) + w(Z) + z(W) + w(Y)$. But $(x(Y), y(X), z(X), w(Y))$ is the coordinates of the first vertex and $(x(Z), y(W), z(W), w(Z))$ is the coordinates of the second. So, sum of two vertices lies on the plane $X + Y = Z + W$, we call this condition *divisibility condition* and it completely defines tropical legendrian lines.

Consider a tropical curve $C \subset \mathbb{T}^3$, pick an edge E of C with two vertices A, B .

Definition 4.2.3. We say that a tropical curve *looks like a legendrian line* along the edge E if

- the edge E is parallel to the vector $(1, 1, 0)$,
- A belongs to the part of \mathbb{T}^3 where $X + Y < Z$, degree of A is three, and two other edges (others than E) from A are parallel to $(1, 0, 0)$ and $(0, 1, 0)$,
- B belongs to the part of \mathbb{T}^3 where $X + Y > Z$, degree of B is three, and two other edges (others than E) from B are parallel to $(0, 0, 1)$ and $(1, 1, 1)$.

We say that C satisfies the tropical legendrian divisibility property along E if C looks like legendrian line along E and the middle point of E belongs to the plane $X + Y = Z$.

We say that C satisfies the tropical legendrian divisibility property if for each edge E of C , either C does not look like a legendrian line along E or C satisfies the tropical legendrian divisibility property along E .

Proposition 4.2.4. All the tropical lines satisfying the tropical legendrian divisibility property can be obtained as tropical limits of complex legendrian curves.

Proof. If a tropical line has vertices of the type $(A, B, C), (A', B', C')$ with $A + A' + B + B' = C + C'$ then these two points are of the following types.

- $(A, B, A + B + X), (A + X, B + X, A + B + X)$ and the corresponding family of legendrian curves are $(t^A + t^A s, 2t^B + t^B s, t^{A+B+X} + t^{A+B} s)$
- $(A, B, A + B), (A + X, B, A + B + X)$ and $(t^A + t^A s, t^B + t^{B-X} s, t^{A+B} - (t^{A+B} - t^{A+B-X}) s)$
- $(A, B, A + B), (A, B + X, A + B + X)$, similar to the previous case.

□

4.2.2 Tropical legendrian cubic curves via Macaulay2

We found all the legendrian cubics through $(0, 0, 0, 1), (1, 1, 1, 1), (-1, 1, -1, 1)$, but if we tropicalize these points, they go to $(-\infty, -\infty, -\infty), (0, 0, 0), (0, 0, 0)$ in the affine coordinates, which seems to be not very interesting. We want to tropical tropical legendrian curves through three points $(X_1, Y_1, Z_1), (X_2, Y_2, Z_2), (X_3, Y_3, Z_3) \in \mathbb{T}^3$ with different Z_1, Z_2, Z_3 and $X_i + Y_i \leq Z_i$. We start with an example.

Example 4.2.5. Let $(X_1, Y_1, Z_1) = (9, 2, 14), (X_2, Y_2, Z_2) = (-16, -23, -2)$, and $(X_3, Y_3, Z_3) = (-31, -22, -12)$. Then, by direct calculation we can find the tropical cubic, it is given by $\max(3x + 321, 2x + y + 328, 2x + z + 327, 2x + 325, x + y + z + 334, x + y + 332, x + z + 347, x + 2y + 335, x + 2z + 349, x + 337, 3y + 342, 2y + z + 340, 2y + 328, y + 2z + 356, y + 342, y + z + 354, 3z + 347, 2z + 361, z + 359, 347)$

Then we can directly find one of the legendrian curves, it is drawn in the surface.

```
fs = {3*x + 321, 2*x + y + 328, 2*x + z + 327, 2*x + 325, x + y + z + 334, x + y + 332,
      x + z + 347, x + 2*y + 335, x + 2*z + 349, x + 337, 3*y + 342, 2*y + z + 340,
      2*y + 328, y + 2*z + 356, y + 342, y + z + 354, 3*z + 347, 2*z + 361, z + 359, 347};
conds = Table[Equal @@ fs1,
  And @@ Table[First@fs1 >= f, {f, Complement[fs, fs1]}], {fs1, Subsets[fs, {2}]}];
aa = ContourPlot3D[
  x - y == 15, {x, -50, 50}, {y, -50, 50}, {z, -50, 50},
  ContourStyle -> {Yellow, Opacity[0.5]},
  AxesLabel -> {"x", "y", "z"}];
cc = Graphics3D[{PointSize[Large], Green, Point[{9, 2, 14}], Green,
  Point[{-16, -23, -2}], Green, Point[{-31, -22, -12}]}];
```

```

bb = Table[
  ContourPlot3D[Evaluate@First@c, {x, -32, 50}, {y, -32, 50}, {z, -32, 50},
    RegionFunction -> Function[{x, y, z}, Last@c], AxesLabel -> {x, y, z},
    ContourStyle -> Directive[Orange, Opacity[0.5]]], {c, conds}];
s1 = Graphics3D[{AbsoluteThickness[10], Blue,
  Line[{{26/3, 26/3 - 15, -50}, {26/3, 26/3 - 15, -12}}]}];
s2 = Graphics3D[{AbsoluteThickness[10], Blue,
  Line[{{26/3, 26/3 - 15, -12}, {12, -3, 2}}]}];
...
(*s1,s2,... stands for parts of the blue tropical curve *)
Show[bb, cc, s1, s2, s4, s5, s6, s7, s8, s9, s10, s11, s12, s13, s14, s15,
  PlotRange -> {{-20, 20}, {-20, 20}, {-20, 20}}]

```

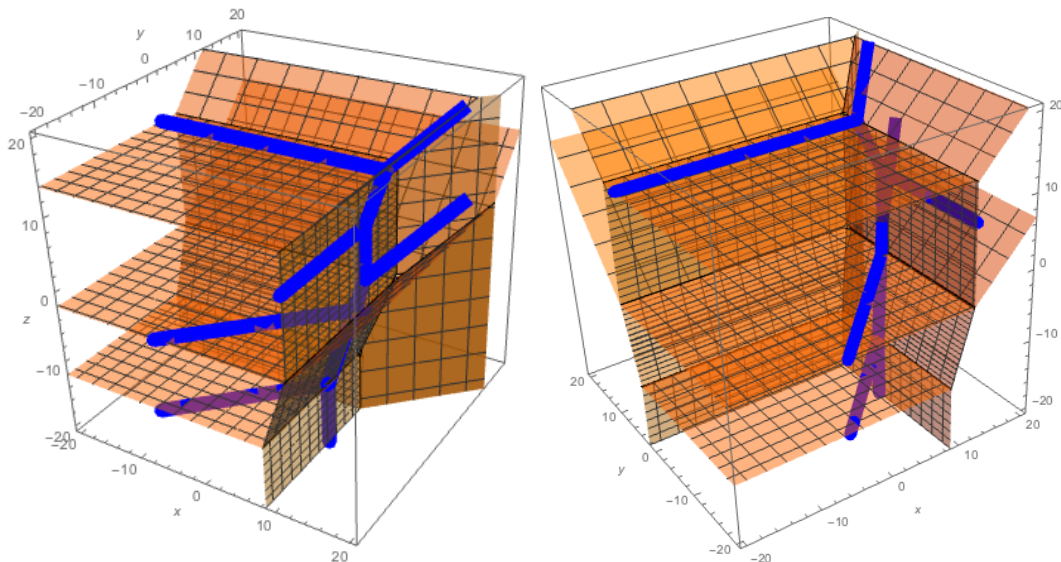

Figure 4.1: The tropical cubic containing all the legendrian cubics through $(9, 2, 14), (-16, -23, -2), (-31, -22, -12)$.

On Figure 4.1 we see that even though the three chosen points are in the part $X + Y < Z$, we can not guarantee that the part of the curve in $X + Y > Z$ will be in one plane of the type $X - Y = c$.

If we choose our three fixed points not in the part $X + Y < Z$, then the picture becomes even more complicated, see Figure 4.2.

4.2.3 Code for producing tropical legendrian curves and their spanning surface

We want to draw the tropical cubic surface which contain the tropical legendrian lines through three fixed points. So, we choose three points, which have desired tropical limits as t tends to infinity. Then, using code in Section 4.2 we find the contactomorphic matrix M which brings our points to

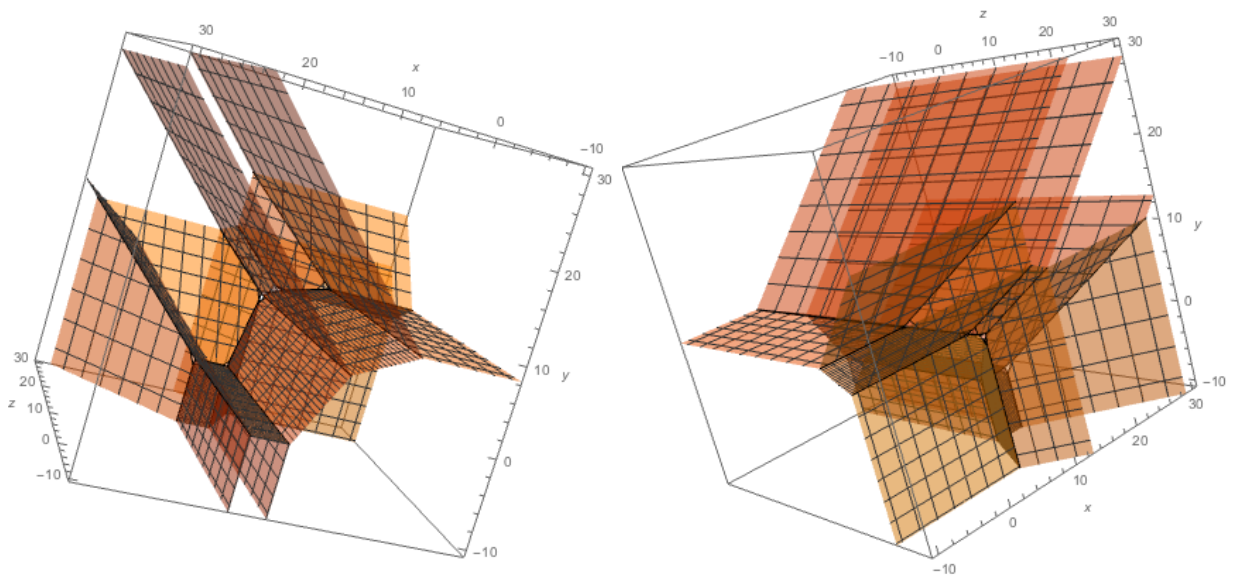

Figure 4.2: The tropical cubic containing all the legendrian cubics through $(20, 2, 17)$, $(20, 18, 25)$, $(12, 20, 5)$.

the standard ones, and then we know the explicit equation (4.8) for the cubic surface, containing all the legendrian rational cubics through these three standard points. Using M , we obtain the equation of such a surface for our points, then we take the valuation.

```
S=QQ[p]
```

```
a1=2*p^(13)
b1=2*p^(20)
c1=p^(33)
a2=2*p^(11)
b2=2*p^(5)
c2=p^(31)
a3=2*p^(4)
b3=2*p^(13)
c3=2*p^(27)
```

```
M1=transformation(a1,b1,c1,a2,b2,c2,a3,b3,c3,S);
R=S[symbol x, symbol y, symbol z, symbol w, s, m, Degrees=>
    {{1,0,0},{0,1,0},{0,0,1},{0,0,0},{0,0,0},{0,0,0}}]
```

```
M3=matrix{{x},{y},{z},{w}}
mma=(inverseMatrix(M1,S)*M3)_0
(x1,y1,z1,w1)=(mma_0,mma_1,mma_2,mma_3)
```

```

g=cubicSurface(x1,y1,z1,w1)

leadterms2:=(ww)->(
(M,C):=coefficients(ww, Variables=>{x,y,z,w});
C1:=matrix(for i in entries(C_0) list (degree lift(leadTerm(i),S)));
(M*C1)_(0,0))
gg=leadterms2(g)

mon = {x^3,x^2*y,x^2*z,x^2*w,x*y*z,x*y*w,x*z*w,x*y^2,
x*z^2,x*w^2,y^3,y^2*z,y^2*w,y*z^2,y*w^2,y*z*w,z^3,z^2*w,z*w^2,w^3}
ggg=for i in mon list ((matrix{degree(i)}* matrix{{x},{y},{z},{0}})+coefficient(i,gg))
ans= html(for i in ggg list i_0_0)

```

The variable *ans* gives us

```

{3*x+228, 2*x+y+217, 2*x+z+208, 2*x+236, x+y+z+203, x+y+230, x+z+223, x+2*y+209,
x+2*z+192, x+250, 3*y+200, 2*y+z+196, 2*y+223, y+2*z+185, y+243, y+z+216,
3*z+172,2*z+205, z+236, 263}

```

which we put into the code in Example 4.2.5 as *fs*. This gives the following pictures, Figure 4.3:

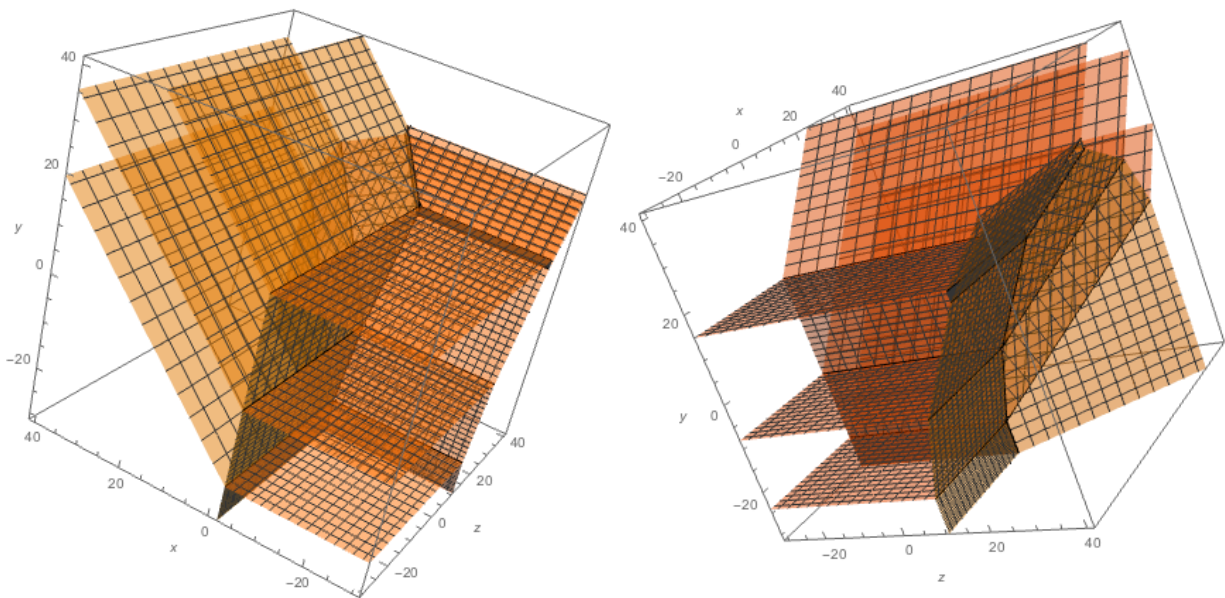

Figure 4.3: The tropical cubic containing all the legendrian cubics through $(13, 20, 33)$, $(11, 5, 31)$, $(4, 13, 27)$.

Example 4.2.6. Now we are ready to find some concrete examples of tropical legendrian rational cubic curves. A priori, it is not simple, because all what we have is only the parametrization of a

curve. If we try to directly take the valuation of the parametrization, we obtain only a part of our curve. So, we will use another approach. A rational curve can be determined by the roots of its coordinates. So, if a curve has a parametrization of the type $(x(s), y(s), z(s), w(s))$, we find x_0, x_1, x_2 which approximate the roots of $x(s)$, i.e. $\text{val}(x(x_i)) \ll 0$, then we do the same for other coordinate functions. Then we can calculate $(\text{val}(x(x_0)), \text{val}(y(x_0)), \text{val}(z(x_0)), \text{val}(w(x_0)))$, and then the same for $x_i, y_i, z_i, w_i, i = 1, 2, 3$.

While trying to find x_0 we sometimes experience the problem that we need to take square or cubic roots. The way to avoid such problems is to choose an appropriate prime number such that the Newton method for finding roots of polynomials.

```

S=QQ[p]
N=2897
S=ZZ/N[p]
a1=1/p^4
b1=1/p^4
c1=p^4
a2=3*p^12
b2=4/p^8
c2=5*p^(12)
a3=6*p^16
b3=7*p^(8)
c3=2*p^(32)

R=QQ[s,m,t,Inverses => true,MonomialOrder => Lex]
if char(S)>0 then R=ZZ/N[s,m,t,Inverses => true,MonomialOrder => Lex]
var={s,m}
mapR=map(R,S,{t})
M1=transformation(a1,b1,c1,a2,b2,c2,a3,b3,c3,S);
T1=mapR(M1);

--function f(s) of degree 3, starting point x0, number of iterations is k
newton:=(f,s0,k)->(
  s1:=s0;
  f1:=sub(f,{s=>s+s1});
  (a,b):=coefficients(f1,Variables=>{s});
  d1:=degree leadTerm(b_0_3);
  d2:=degree leadTerm(b_0_2);
  d:=d1-d2;
  den:=0;
  cc:=0;
  for i from 1 to k do(
    f1:=sub(f,{s=>s+s1});
    (a,b)=coefficients(f1,Variables=>{s});

```

```

        d1=degree leadTerm(b_0_3);
d2=degree leadTerm(b_0_2);
d=d1-d2;
cc=(coefficient(t^(d2_0),leadTerm(b_0_2)));
if char(R)==0 then den=1/cc else (
    for i from 1 to N do (if mod(i*cc-1,N)==0 then den=i);
    );
s1=s1-t^(d_0)*(coefficient(t^(d1_0),leadTerm(b_0_3)))*den;
);
    s1
)

--calculates the valuation of curve f(s,m) with s=s1 and mu=m1
--then the resulting affine coordinate
setpoint:=(s1,m1,curve)->(
    point:=sub(curve,{s=>s1,m=>m1});
    ll:=degree(point_0_3);
    (degree(point_0_0) -ll,degree(point_0_1) -ll,degree(point_0_2) -ll)
)

leadterms:=(ww)->(
(M,C):=coefficients(ww, Variables=>var);
C1:=transpose matrix{for i in entries(C_0) list (degree leadTerm(i))_0};
(M*C1)_(0,0))

Tcoeff:=(w)->(coefficients(w,Variables=>{s})
)

--2 all contact cubic curves
curve=matrix{{-s^3+3*s},{2*s^2+m*(s-s^3)},{2*s^3},{s^2+1 - m*(s-s^3)}}
result1=T1*curve;
result=result1;
--3 we have result1, which is the curve over S, need to draw, but...
x:=result_0_0;
y:=result_0_1;
z:=result_0_2;
w:=result_0_3;
for i from 0 to 3 do (print leadterms(result_0_i))

m0=t^2
for i from -30 to 5 do print setpoint(t^(i),m0,result)
f=sub(z,{m=>m0,s=>s});

leadterms(x)

```



```
f=sub(x,{m=>m0});
rx1=newton(f,t^(-18),10)
rx2=newton(f,1,10)
rx3=newton(f,-1,10)
setpoint(rx3,m0,result)
```

```
leadterms(y)
f=sub(y,{m=>m0})
ry1=newton(f,t^(-4),20)
ry2=newton(f,1,10)
ry3=newton(f,-1,10)
setpoint(ry2,m0,result)
```

```
leadterms(z)
f=sub(z,{m=>m0});
rz1=newton(f,t^(-10),10)
rz2=newton(f,94*t^(-1),10)
rz3=newton(f,-94*t^(-1),10)
setpoint(rz3,m0,result)
```

```
leadterms(w)
f=sub(w,{m=>m0});
rw1=newton(f,-1+t^(-10),10)
rw2=newton(f,-1+132*t^(-5),10)
rw3=newton(f,-1-132*t^(-5),10)
setpoint(rw1,m0,result)
```

As always, the first few terms of the roots we need to find by hands, look at w -coordinate. The number 132 and 2897 are chosen in such a way that the series in t for roots of w may be written using integer (finally, sure, from a finite field) coefficients.

Calculating $setpoint(..., m0, results)$ for $...=rx1, rx2, ...rw3$ we obtain the following points on our curve: $(-4, 8, 32), (22, -12, 32), (-8, -2, 12), (12, -28, 12), (-24, -4, 4), (10, -44, 6), (13, -1, -1), (13, -1, -3), (8, -4, -16), (44, 30, 52), (37, 23, 40), (37, 23, 40)$.

So, we find the vertices of our curve: $(22, 8, 32), (12, -2, 12)$ — these are the vertices lying in the planes $Z = 32$ and $Z = 12$. As it should be, $X - Y = 14$ for both vertices as the rest of the curve in the part $X + Y > Z$ should be in a plane $X - Y = c$. But at the bottom we see a different picture. The leg going to $-\infty$ by X coordinate comes to the vertex $(8, -4, 4)$ on $X + Y = Z$, where the leg going to $-\infty$ by Z -coordinate branches. Then the curve goes to $(10, -4, 6)$, where the leg, going to $-\infty$ by Y -coordinate, branches. Also, the curve came to the plane $X - Y = 14$ in order to unify with the other parts of the curve. The rest of the curve is also uniquely determined, see Figure 4.4.

As we see in this example, we have a part of tropical cubic curve which looks like a tropical line. Also, it has vertices $(22, 8, 32)$ and $(24, 10, 32)$. As we see, $(22 + 8) + (24 + 10) = 32 + 32$, i.e. the middle point of the interval between the vertices is on the plane $X + Y = Z$.

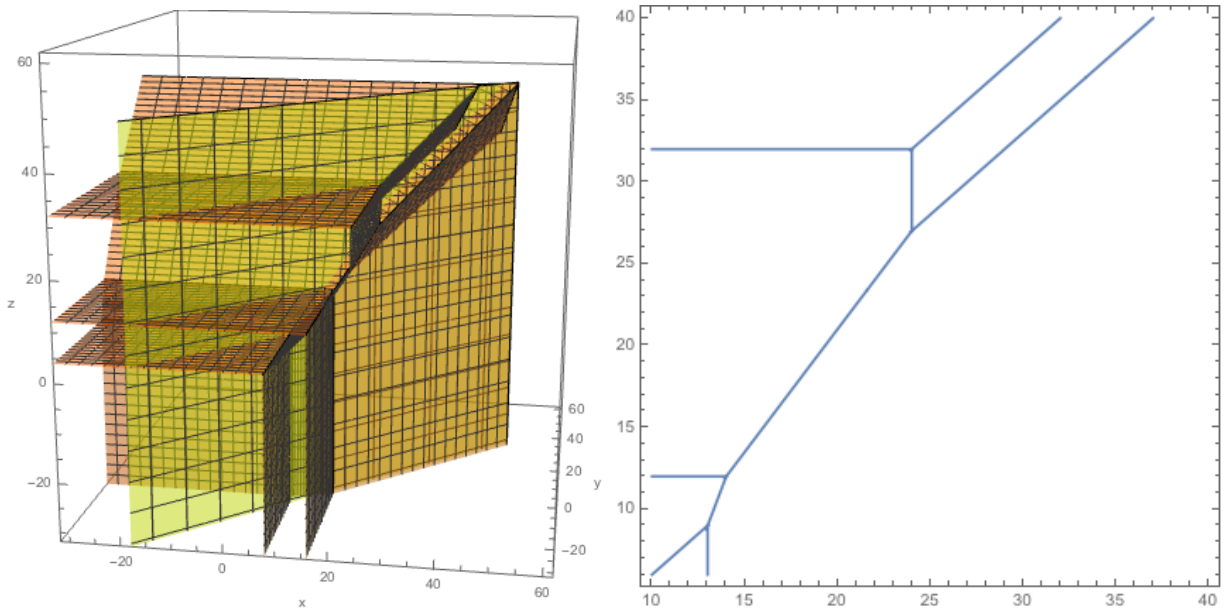

Figure 4.4: On the left, the tropical cubic surface and the plane $X - Y = 14$, on the right we see the part of our curve, in $X - Y = 14$ with $X + Y \geq Z$.

We list here the values of the coordinates at the roots of the other coordinates.

$$\begin{pmatrix} -\infty & 8 & 32 & 0 \\ -\infty & -2 & 12 & 0 \\ -\infty & -4 & 4 & 0 \end{pmatrix} \quad \begin{pmatrix} 10 & -\infty & 6 & 0 \\ 12 & -\infty & 12 & 0 \\ 22 & -\infty & 32 & 0 \end{pmatrix} \quad \begin{pmatrix} 13 & -1 & -\infty & 0 \\ 13 & -1 & -\infty & 0 \\ 8 & -4 & -\infty & 0 \end{pmatrix} \quad \begin{pmatrix} 14 & 0 & 22 & -\infty \\ 14 & 0 & 17 & -\infty \\ 14 & 0 & 17 & -\infty \end{pmatrix}$$

This example is related to Question 19. It is not clear what and how should something be added in order to obtain a similar identity. Direct attempt would be something like the following. Denote by $Y(X)$ the sum of Y -coordinate at the roots of X -coordinate. If we try to verify the identity $Y(X) - Z(X) = W(Z) - X(Z)$, we see that it does not hold.

4.3 Tropical differential forms

4.3.1 Infinitesimal considerations via logarithmic Gauss derivative

We define logarithmic Gauss derivative, cf. [103, 110, 131].

Definition 4.3.1. For $s \in \mathbb{K}$ and $f : \mathbb{K} \rightarrow \mathbb{K}$ we define the *logarithmic Gauss derivative* γ^{trop} at s by $(\gamma^{\text{trop}} f)(s) = s \frac{f'(s)}{f(s)}$. So, $\gamma^{\text{trop}} f$ is a function $\mathbb{K} \rightarrow \mathbb{K}$.

We are going to study the logarithmic Gauss derivatives of tropical functions. We start with a polynomial $f : \mathbb{K} \rightarrow \mathbb{K}$ where \mathbb{K} is a valuation field, $f(s) = \sum_{i=0}^n a_i s^i$. The tropicalization of f is $\text{Trop}(f)(S) = \max_{i=0}^n (\text{val}(a_i) + iS)$, where $S = \text{val}(s)$ is the tropical parameter.

Lemma 4.3.2. Consider $s \in \mathbb{K}, S = \text{val}(s)$ and k such that $\text{val}(a_k) + kS > \text{val}(a_i) + iS$ for all $i \in 0, \dots, n, i \neq k$. In this case,

- if $k \neq 0$, then $\text{val}(f'(s)) = \text{val}(f(s)) - \text{val}(s)$. Also, $\gamma^{\text{trop}}f(s) = k + \text{higher order terms}$, $\text{val}(\gamma^{\text{trop}}f(s)) = 0$;
- if $k = 0$, then $\text{val}(f'(s)) < \text{val}(f(s)) - \text{val}(s)$, and $\text{val}(\gamma^{\text{trop}}f(s)) < 0$.

Proof. We calculate $f'(s) = \sum_{i=1}^n ia_i s^{i-1}$. Note that $\text{val}(a_i s^i) = \text{val}(ia_i s^{i-1}) + S$ except the case $i = 0$. Therefore $\max_{i=0}^n (\text{val}(a_i) + iS) = \max_{i=1}^n (\text{val}(ia_i) + (i-1)S) + S$ everywhere except the place where the maximum is attained for $i = 0$. To resolve the case $i = 0$ we consider $g = \sum_{i=1}^n a_i s^i$. Clearly, $f' = g'$, $\text{val}(g(s)) < \text{val}(f(s))$ for s such that the monomial a_0 strictly dominates all the $a_i s^i$ in f . Now, for the function g we have the equality $\text{val}(g'(s)) = \text{val}(g(s)) - \text{val}(s)$, which concludes the proof. \square

4.3.2 Tropical legendrian lines and tropical forms

We consider a rational cubic curve C over \mathbb{K} parametrized by

$$(x, y, z, w) = (a_0 + a_1 s + a_2 s^2 + a_3 s^3, b_0 + b_1 s + b_2 s^2 + b_3 s^3, c_0 + c_1 s + c_2 s^2 + c_3 s^3, d_0 + d_1 s + d_2 s^2 + d_3 s^3). \quad (4.9)$$

Lemma 4.3.3. If $C \subset \mathbb{K}^3$ is legendrian curve, a point $p = (x, y, z) \in C$ and $\text{val}(xy) > \text{val}(z)$, then the difference between the X -coordinate and Y coordinate of $\text{Trop}(C)$ near $\text{Val}(p)$ is locally constant.

Proof. We substitute this parametrization into the form $\omega = ydx + xdy + wdz + zdw$. Let us choose local parametrization such that $w = 1$. The condition that our curve is legendrian is

$$x(s)y(s) \left(\frac{x'(s)}{x(s)} - \frac{y'(s)}{y(s)} \right) + z(s) \left(\frac{z'(s)}{z(s)} \right) = 0. \quad (4.10)$$

Locally, $\text{val}(x(s)), \text{val}(y(s)), \text{val}(z(s))$ are tropical polynomials, so we can apply the reasoning from Lemma 4.3.2. Since $\gamma^{\text{trop}}z(s) = \text{val}\left(\frac{dz}{z}(s)\right) + \text{val}(s)$ is at most zero, then in order to have zero in (4.10) we need that $\text{val}(s) \left(\frac{x'(s)}{x(s)} - \frac{y'(s)}{y(s)} \right) < 0$ by Lemma 4.3.2, i.e. $\gamma^{\text{trop}}x(s) = \gamma^{\text{trop}}y(s)$ locally. Therefore either the leading term is constant in both $x(s), y(s)$, or $\gamma^{\text{trop}}x(s) = k + \text{higher order terms}$, and $\gamma^{\text{trop}}y(s) = l + \text{higher order terms}$, and so we have to have $k = l$. \square

Proposition 4.3.4. Analogously, we can prove that in the part $\text{val}(xy) < \text{val}(z)$ a tropical legendrian curve has locally constant Z -coordinate.

Definition 4.3.5. A tropical curve $C \subset \mathbb{T}^3 = \{(X, Y, Z) | X, Y, Z \in \mathbb{T}\}$ satisfies the *tropical legendrian tangency property*, if in the part of the space $X + Y > Z$ this curve C is tangent to the distribution $dX - dY$, and in the part $X + Y < Z$ this curve C is tangent to the distribution dZ . In other words, if $Z > X + Y$ (resp. $Z < X + Y$), then the curve locally lies in a plane of the type $Z = \text{const}$ (resp. $X - Y = \text{const}$).

Proposition 4.3.6. A tropical legendrian curve $C \subset \mathbb{TP}^3$ (Definition 4.2.1) satisfies the tropical legendrian tangency property.

In particular, all the edges \overline{E} of C with endpoints on different sides of the plane $X + Y = Z$ are parallel to the vector $(1, 1, 0)$.

Proof. Indeed, this proposition follows from Lemma 4.3.3 and Proposition 4.3.4. \square

Proposition 4.3.7. A tropical line $L \subset \mathbb{T}^3$ is a tropical legendrian line (Definition 4.2.1) if and only if L satisfies the tropical legendrian divisibility property (Definition 4.2.3) and the tropical legendrian tangency property (Definition 4.3.5).

Proof. We just verify that all the tropical legendrian lines (we have the full description in Proposition 4.2.4) satisfy the hypothesis of our proposition. \square

4.3.3 Tropical divisibility property for curves

Here we prove a version of the divisibility property (Definition 4.2.3) for the rational curves which have only one intersection with the plane $w = 0$, such a curve always has a parametrization of the type

$$(a_0 + a_1s + a_2s^2 + \dots, b_0 + b_1s + b_2s^2 + \dots, c_0 + c_1s + c_2s^2 + \dots, 1) \subset \mathbb{K}P^3. \quad (4.11)$$

Suppose that somewhere our parametrization looks like

$$(x(s), y(s), z(s)) = (\dots + a_l s^l + \dots + a_k s^k + \dots, \dots + b_k s^k + \dots, c_0 + \dots + c_p s^p + \dots) \quad (4.12)$$

in the affine coordinates. This notation means that on the interval for s that we consider, at the beginning, the monomials $a_l s^l, b_k s^k, c_0$ are the dominating monomials in the x, y, z coordinate respectively. Then, at some moment, $s = s_1$ in the x -coordinate the monomial $a_k s^k$ becomes dominant. And then, at some moment $s = s_2$ the monomial $c_p s^p$ becomes dominant in the z -coordinate. We suppose that nothing more happens during this period of time. That means that the tropicalization C of our curve has the following behavior in between on $\text{val}(s_1) \leq S \leq \text{val}(s_2)$. The curve starts in the part $Z \geq X + Y$ of the space and has a vertex P at $S = \text{val}(s_1)$, because $\text{val}(a_l s_1^l) = \text{val}(a_k s_1^k)$ and C change its direction. Then C goes to the part $Z < X + Y$ and has a vertex Q there, when $\text{val}(c_0) = \text{val}(c_p s_2^p)$. Also, these conditions mean that the leg of C which goes from B to $-\infty$ by Z -coordinate does not branch.

Theorem 4.3.8. In the above hypothesis, $(k - l)P + pQ$ belongs to the plane $X + Y = Z$.

Proof. Let us find the valuation of the parameter s at the roots s_1, s_2 of the first and the third coordinates, respectively. Then $\text{val}(s_1) = \frac{\text{val}(a_l) - \text{val}(a_k)}{k - l}$, $\text{val}(s_2) = \frac{\text{val}(c_0) - \text{val}(c_p)}{p}$. We denote $A_k = \text{val}(a_k)$, $B_k = \text{val}(b_k)$, etc.

Therefore the coordinates of these two vertices of C are given by

$$\begin{aligned} A &= (A_k + k \frac{A_l - A_k}{k - l}, B_k + k \frac{A_l - A_k}{k - l}, C_0), \\ B &= (A_k + k \frac{C_0 - C_p}{p}, B_k + k \frac{C_0 - C_p}{p}, C_0). \end{aligned} \quad (4.13)$$

The condition that $(k - l)A + pB$ belongs to the plane $X + Y = Z$ is the following:

$$\begin{aligned} (k - l)A_k + k(A_l - A_k) + (k - l)B_k + k(A_l - A_k) + pA_k + \\ k(C_0 - C_p) + pB_k + k(C_0 - C_p) = (k - l + p)C_0. \end{aligned} \quad (4.14)$$

So we need to verify that

$$A_k(k-l-k-k+p) + A_l(k+k) + B_k(k-l+p) = 2kC_p + C_0(k-l+p-2k). \quad (4.15)$$

Since $ydx - xdy + dz = 0$, we have

$$(b_k s^k)(la_l s^{l-1} + ka_k s^{k-1}) - (a_l s^l + a_k s^k)kb_k s^{k-1} = pc_p s^{p-1}.$$

This implies $p-1 = k+l-1$ and $(k-l)a_l b_k = pc_p$ i.e. $A_l + B_k = C_p$. Finally, it is easy to verify that (4.15) follows from the equalities $p-k-l=0$ and $A_l + B_k = C_p$. \square

Remark 4.3.9. We can reformulate the conditions (4.11),(4.12) as follows. We consider a part of a tropical curve C , an edge PQ of C , with the following conditions. The direction of the edge PQ is $(k, k, 0)$, the direction of edges from P are $(l, k, 0)$ and $(k-l, 0, 0)$, these edges are infinite legs of C . Also Q has a vertical infinite leg in the direction $(0, 0, p)$.

4.3.4 Divisibility conditions for “line”-similar parts of the tropical rational legendrian cubics

Theorem 4.3.10. Suppose that a tropical rational legendrian cubic looks like a tropical legendrian line (Definition 4.2.3) along an edge PQB . Then the middle point $(P+Q)/2$ of this edge PQ belongs to the plane $X + Y = Z$.

Proof. Since our curve is a rational cubic, we always can choose a local parameter s such that this part is given by

$$(a_0 + a_1 s + \dots, b_0 + b_1 s + \dots, c_0 + c_1 s + \dots, d_0 + d_1 s + \dots) \quad (4.16)$$

or

$$(a_1 s + a_2 s^2 + \dots, b_0 + b_1 s + b_2 s^2 + \dots, c_0 + c_1 s + c_2 s^2 + \dots, d_0 + d_1 s + \dots) \quad (4.17)$$

such that for some parameter s_0 we have $\text{val}(a_1 s_0) = \text{val}(a_2 s_0^2)$, $\text{val}(b_1 s_0) = \text{val}(b_2 s_0^2)$, $\text{val}(c_1 s_0) = \text{val}(c_2 s_0^2)$, $\text{val}(d_0) = \text{val}(d_1 s_0)$, because the second parametrization also looks like a line. We use the same notation as in the previous section.

In the first case the proof is the same as for line, because we do not see the higher degree terms. For the second case, it is also a computation. We evaluate the contact form on the curve and obtain $b_0 a_1 + d_0 c_1 - c_0 d_1 + s(2a_2 b_0 + 2d_0 c_2) + s^2(\dots)$. This means $A_2 + B_0 = D_0 + C_2$ and $B_0 + A_1 = C_0 + D_1$ because $C_1 - C_0 < D_1 - D_0$. Now we compute the coordinates of the vertices of the curve, they happen to be $(A_1 + B_0 - B_1, B_0, C_0, D_0)$ and

$$(A_2 + 2(C_1 - C_2), B_2 + 2(C_1 - C_2), 2C_1 - C_2, D_0), \quad (4.18)$$

we need to verify that

$$A_1 + 2B_0 - B_1 + A_2 + B_2 = C_0 + D_0 + 2C_2 + D_1 - C_1. \quad (4.19)$$

This follows from $B_1 - B_2 = C_1 - C_0 = A_1 - A_2 = D_0 - D_1$, $B_0 + A_2 = D_0 + C_2$. \square

4.4 Tropical differential forms in legendrian geometry

We start with an example; then we briefly explain how this example proves the tropical legendrian divisibility property. A formal proof with complete definitions will appear elsewhere.

4.4.1 Integration on a tropical line

Consider the line $x + y + 1 = 0$ and the form $\Omega = \frac{dx}{x}$ on it. We are going to study the behavior of all these objects in the tropical limit, i.e. after the map Log_t as $t \rightarrow \infty$. Namely, we consider the map f_t obtained as $\text{Log}_t(\mathbb{C}^*)^2 \rightarrow \mathbb{R}^2$ followed by a retraction to the tropical curve C given by $\max(X, Y, 0)$. Retraction is given by the map $r_C : \mathbb{R}^2 \rightarrow C$ sending each point in \mathbb{R}^2 to the closest point in C . So, $f_t = r_C \circ \text{Log}_t$.

Consider the integral of Ω over a preimage of the point $(-a, 0)$ for $a > 0$. We have $\int_{f_t^{-1}(-a, 0)} \Omega = 1$, because the curve $f_t^{-1}(-a, 0) = (\alpha t^{-a} + o(t^{-a}), 1 - \alpha t^{-a} + o(t^{-a}))$, $\alpha \in \mathbb{C}$, $|\alpha| = 1$, is a circle around a pole of Ω . The same is true for a point (a, a) , $a > 0$. But the integral of Ω over the preimage of $(0, -a)$ is zero. Now we consider integral over pre-images of the intervals.

Let s be a lift of the interval $[(-a, 0), (-a + e, 0)]$ using f_t^{-1} . It is something like a path from $(t^{-a}, 1 - t^{-a})$ to $(t^{-a+e}, 1 - t^{-a+e})$. Let us assume that s turns around the cylinder only some a priori bounded number R of times. Then, the integral of Ω over this path is equal to a logarithm, up to the constant R . So, $\int_s \Omega$ is $\log(t^{-a+e}) - \log(t^{-a})$, i.e. $\frac{e}{\ln(t)}$. The same formula holds when we take a lift of a path on the diagonal edge of the tropical line.

Now compute integrals over vertical edge. Consider the following lift of $[(0, -a), (0, -a - e)]$: take s as the preimage of a path from $(1 - t^{-a}, t^{-a})$ to $(1 - t^{-a-e}, t^{-a-e})$. The integral of Ω over this path equals to $\log(1 - t^{-a-e}) - \log(1 - t^{-a}) \sim \frac{t^{-a}}{\ln t}$. Similar effect can be observed for an abstract tropical curve and a differential of the given type on it.

4.4.2 Tropical differential forms

Consider a tropical curve C . Let E be the set of edges of C , we take each edge in two exemplars, with different orientations, the edge $-e$ is the edge $e \in E$ with reversed orientation. For a vertex v of C we denote by $\text{deg}(v)$ the degree of v . Also we suppose that each vertex of C is equipped with a non-negative integer number $g(v)$, the ‘‘genus’’ at v . A tropical differential form is a linear form on the oriented edges of C , i.e. a correspondence $\Omega^{\text{trop}} E \rightarrow \mathbb{Z}$ with $\Omega^{\text{trop}}(-e) = -\Omega^{\text{trop}}(e)$ for all $e \in E$.

More detailed exposition of the following notions can be found in [96] (Definitions 1.25, etc).

Definition 4.4.1. We consider a family of forms Ω_t on the curves C_t with only imaginary periods. We say that this family converges to a tropical curve C and a differential form Ω^{trop} if there is a family of maps $p_t : C_t \rightarrow C$ with the following properties.

- if $x \in C$ is not a vertex, then $p_t^{-1}(x)$ is circle,
- if $x \in C$ is a vertex of C , then $p_t^{-1}(x)$ is a surface of genus $g(v)$ with $\text{deg}(v)$ boundary components,
- if $x, y \in C$ belong to the interior of an edge $e \in E$, then the length of the shortest geodesic between two points in $f^{-1}(x)$ and $f^{-1}(y)$ is of the order $\ln \rho(x, y) + \ln \ln t$, where $\rho(x, y)$ is the distance between x and y on e .

- if $x \in C$ is not a vertex, x belongs to an edge $e \in E$, then $\omega(x, t) = \int \Omega^{\text{trop}}$ over $p_t^{-1}(x)$ satisfies

$$\frac{1}{2\pi i} \lim_{t \rightarrow 0} \omega(x, t) = \Omega^{\text{trop}}(e) \quad (4.20)$$

Here we suppose that the circle $p_t^{-1}(x)$ is oriented in such a way that the pull-back of E to C_t and the tangent vector to the circle give the oriented basis of C_t .

Proposition 4.4.2. It follows from the definition that if $x, y \in C$ belong to the interior of an edge $e \in E$, then for any liftings $x' \in p_t^{-1}(x), y' \in p_t^{-1}(y)$ and s is a path (shortest possible) between x', y' , then $\lim_{t \rightarrow 0} \log_t(\int_s \Omega_t) = \Omega^{\text{trop}}(e) \cdot \rho(x, y)$.

Note that on the edges e with $\Omega(e) = 0$ we can find the next term in the Taylor expansion of $\lim_{t \rightarrow 0} \log_t(\int_s \Omega_t)$ in t . We generalize the example in Section 4.4.1 as follows. Let C has a vertex P as a tropical line and $\omega = \frac{dx}{x} - \frac{dy}{y}$. Then, Ω^{trop} is 1 on two edges from P and 0 on the third edge e .

Lemma 4.4.3 (Refined value of a tropical form). In this case, Ω^{trop} on e can be thought as $0 + \ln t \cdot t^a$, where a is the distance to the vertex, in the sense of above expansion in t .

Question 21. It seems that the same lemma holds in all the contexts of tropical geometry (hyperbolic, analytical, complex), so it should be a language exercise to rewrite the proof (and corresponding notions from [96]) in their languages.

4.4.3 Application of refined value of a tropical form to legendrian curves

Suppose that we have a tropical legendrian curve C which looks like a tropical legendrian line (Definition 4.2.3) along an edge $e \subset C$. Then we consider the form $(\frac{dx}{x} - \frac{dy}{y})$ on the left part of e . As we can see, it satisfies the hypothesis of Lemma 4.4.3. So, take the point P at the intersection of C with the plane $X + Y = Z + W$. Then the refined value of $(\frac{dx}{x} - \frac{dy}{y})^{\text{trop}}$ at P is $\ln t \cdot t^{-l}$ where l is the distance from P to the left vertex of e . We do the symmetric stuff for the right hand side of the tropical curve and contact form, we get $(\frac{dz}{z} - \frac{dw}{w})^{\text{trop}} = \ln t \cdot t^{-l'}$ where l' is the distance from P to the right vertex of e . Since xy/zw is of order of a constant near P and $(\frac{dx}{x} - \frac{dy}{y}) = \frac{zw}{xy}(\frac{dz}{z} - \frac{dw}{w})$ we conclude that $l = l'$ which proves the tropical legendrian divisibility property in the full generality.

Appendix A

Combinatorics of lattice width

Lattice polytopes materialize as soon as we have a polynomial. V.I. Arnold believed that all reasonable properties of a generic polynomial's zero set can be expressed in terms of its Newton polytope. The simplest invariants are *volume*, *number of integer points*, *lattice width*.

Integer points counting leads to Ehrhart polynomial [17, 152], and has various applications in algebraic geometry [16]. For example, the volumes and mixed volumes of the Newton polyhedra calculate the Euler characteristic of the intersection of corresponding varieties. Another example: Hodge numbers of a toric variety can be read off the faces of its polyhedron [47].

With recent approach to lattice polygons ([38]), a lot of classical properties, i.e. gonality, Clifford index of plane algebraic curves, etc., were interpreted in terms of lattice width ([39]). Also, the lattice width has been used in [100] in a study of families of curves, swiping toric surfaces.

As it has been shown in Chapter 1, singularities with high multiplicities impose conditions on the Newton polygon in terms of its lattice width, these conditions are kind of non-overlapping; see Chapter 2 for details. All that motivates the estimation of the minimal volume of a polytope with a given minimal lattice width. It happened that this problem is deeply related with a lot of classical well-known problems in geometry.

I present here a survey of the state of the art at the current moment. We will dig into the world of Minkowski coverings, successive minima, combinatorics of sphere packing, and Mahler conjecture.

Definition A.0.1. For a set $X \in \mathbb{R}^n$ and an integer vector $u \in \mathbb{Z}^n$ the *lattice width* $\omega_u(X)$ of X in the direction u is $\omega_u(X) = \max_{x,y \in X} (x - y) \cdot u$. The minimal lattice width $\omega(X)$ of X is $\min_{u \in \mathbb{Z}^n \setminus \{0\}} \omega_u(X)$.

Comparing to usual width (when we take u on the unit sphere), the lattice width is much more discrete-oriented object. It is intuitively clear that for each n there exists a constant $c_n > 0$ such that $\text{Volume}(\text{ConvHull}(X)) \geq c_n \omega(X)^n$. The goal was to find the best know estimate for c_3 . The answer is $c_3 \geq \frac{2\pi\sqrt{18}}{405} = 0.06582\dots$ whereas the conjectured value is $c = \frac{1}{12} = 0.083333\dots$

Also, we take an opportunity to formulate a question:

Question 22. The directions of the edges of a tropical curve are dual to edges in a subdivision of its Newton polygon. In general, the tropical hypersurfaces are dual to polytopes. The vertices of tropical curves are responsible for the concentration of the curvature ([20, 40, 93, 143]), so the curvature should be related to the local self-intersections. We consider a surface in \mathbb{C}^4 . Suppose we

know its tropicalization (a fan, for simplicity). How the local properties of the vertex of this fan is related to the curvature of the surface? Can we estimate the self-intersection? What is the dual object for such a vertex?

The book [133] about lattice points reveals a lot of their aspects, particularly in number theory. The notion of successive minima generalizes Minkowski's well-known theorem about a body, containing an integer point. The book [46] provides a lot of applications for sphere packing, in the following we will also want to know the best sphere packing.

Here are some list of links (surely, non-complete) without any implicit connection with the main topic, but I find them worth to mention: balls' lattices [105], covering minima [82], relation between maximal and minimal widths [1], maximal number $(3^d - 1)$ of lattice diameters in higher dimensions [54] (thought it was proved before, in [104] (Corollary 4)). One can estimate the surface area under affine transformations [135].

A.1 An estimation of the volume of a body via its minimal lattice width

Given the minimal lattice width $\omega(D)$ of a convex three-dimensional body D , we want to estimate the volume of D from below. Several general theorems may be applied after a chain of reformulations. Since this chapter is dedicated to calculation of the best known constant in the inequality $\text{Volume}(D) \geq c\omega(D)^3$, we quickly survey all the approaches. The methods of Section 1.8 can be applied, but the combinatorics in three dimensions is much more complex.

Let $D \subset \mathbb{R}^3$ be a compact convex three-dimensional set.

Definition A.1.1. The *lattice width* of D in a direction $u \in \mathbb{Z}^3$ is $\omega_u(D) = \max_{x,y \in D} u \cdot (x - y)$. Lattice width $\omega(D)$ of V is the minimum of all lattice widths on all non-zero directions, $\omega(D) = \min_{u \in \mathbb{Z}^3, u \neq 0} \omega_u(D)$.

It is expectable¹ that there is a constant c_3 such that $\text{Volume}(D) \geq c_3 \cdot \omega(D)^3$. We would like to estimate this constant. Without loss of generality we can suppose that $\omega(D) = 1$ and look for minimal volume of D under this constraint. This c_3 is proven to be at least $\frac{2\pi\sqrt{18}}{405} = 0.06582\dots$, whereas the conjectured one is $c_3 = 1/12$. The following paragraphs summarize the ideas of [104].

Lemma A.1.2. The property $\omega(D) \geq 1$ is equivalent to the property that the lattice of translates of D (i.e. $\{v + D | v \in \mathbb{Z}^3\}$) is **non-separable**, i.e. each hyperplane intersects some body of the lattice. □

The **density** of a lattice translates of D is the ratio of the volumes of D and the basic parallelepiped. Hence the density of our lattice is $\text{Volume}(D)/1$. Therefore $\text{Volume}(D)$ is at least the density of the thinnest (i.e. with minimal density) non-separable lattice of translates of D . Put by definition $E = (\frac{D-D}{2})^*/4$.

Denote by $\rho(D)$ the density of thinnest non-separable lattice, denote by $\delta(E)$ the density of the densest lattice packing of E .

¹Though I don't know a simple argument

Lemma A.1.3 (Theorem 1 in [104]). The property that $D + \mathbb{Z}^3$ is locally thinnest non-separable lattice of bodies is equivalent to the property that $E + \mathbb{Z}^3$ is a locally densest packing of E . \square

Locally means that we have extremum among all infinitesimally near lattices. It follows from this lemma that

$$\text{Volume}(D) \geq \rho(D) = \text{Volume}(D)\text{Volume}(E)/\delta(E). \quad (\text{A.1})$$

Idea is that E does not intersect $E + u$ if $\omega_u(E) \leq |u|^2$, which can be translated in non-separability of the lattice of translates of D . So, we suppose from the beginning that $D + \mathbb{Z}^3$ is a thinnest non-separable lattice of translates of D .

A.1.1 The approach by affinities decreasing the diameter

Hence the initial problem is equivalent to the estimations of densest packing for $E = (\frac{D-D}{2})^*/4$ and its volume. Instead, we are going to replace D with a sphere and play with volume preserving affine transformations. The following lemma is crucial:

Lemma A.1.4. There exists $\lambda_n, \lambda'_n > 0$ that for any convex compact set $D \subset \mathbb{R}^n$ there exists affinity Φ such that $\text{Diam}(\Phi D)^n \leq \lambda_n \text{Volume}(\Phi D)$ for any body D and $\text{Diam}(\Phi D)^n \leq \lambda'_n \text{Volume}(\Phi D)$ for centrosymmetric D .

Preserving the volume of D , we decrease its diameter by affine transformation (this does not change $\rho(D)$) and then replace D by the sphere with the same diameter d , the lattice of such spheres will be also non-separable. So, $\frac{\rho(D)}{\text{Volume}(D)} \geq \frac{\rho(B)}{\text{Volume}(B)}$.

It follows that $\frac{\rho(D)}{\rho(B)} \geq \frac{\text{Volume}(D)}{\text{Volume}(B)} \geq \frac{d^n/\lambda_n}{(\frac{d}{2})^n \kappa_n}$, where κ_n is the volume of unit sphere, $\text{Volume}(B) = \kappa_n (d/2)^n$.

Remark A.1.5. We know values of κ_n : $\kappa_{2n} = \frac{\pi^n}{n!}, \kappa_{2n+1} = \frac{2^{n+1}\pi^n}{(2n+1)!!}$.

By the formula (A.1) for $\rho(B)$ we obtain

Proposition A.1.6.

$$\rho(D) \geq \rho(B) \cdot \frac{2^n}{\lambda_n \kappa_n} = \frac{\kappa_n \cdot \kappa_n / 4^n}{\delta_n} \frac{2^n}{\lambda_n \kappa_n} = \frac{\kappa_n}{2^n \lambda_n \delta_n} \quad (\text{A.2})$$

where δ_n is the density on the densest packing on spheres in \mathbb{R}^n .

The same way for centrosymmetric D we established that $\frac{\rho(D)}{\rho(B)} \geq \frac{\text{Volume}(D)}{\text{Volume}(B)} \geq \frac{\text{Diam}(D)^n}{\lambda'_n \text{Volume}(B)}$, where B is the sphere with diameter equals $\text{Diam}(D)$.

A.1.2 Estimation of λ_n

By κ'_n we denote the volume of the convex hull of the unit sphere with the center at 0 and $(\pm\sqrt{n}, 0, 0, 0)$.

Lemma A.1.7. ([104]) We have $\lambda'_n \leq 2^n n^{n/2} \kappa'_n$ where κ'_n is the volume of the convex hull of the unit sphere, with the center at 0, and the point $(\pm\sqrt{n}, 0, 0, 0)$.

Lemma A.1.8 ([144], Theorem 2.4). In the above hypothesis the inequality

$$\text{Volume}(D)/\text{Volume}\left(\frac{D-D}{2}\right) \geq 2^n/C_{2n}^n \quad (\text{A.3})$$

holds and equality is attained only for simplexes.

Lemma A.1.9. Now² we can estimate λ_n by λ'_n : using $\lambda'_n \leq 2^n n^{n/2}/\kappa'_n$ we get

$$\lambda_n \leq C_{2n}^n n^{n/2}/\kappa'_n$$

Let us compute κ'_3 . It is sum of the volumes of two cones plus the volume of the sphere, cut by $x = \pm 1/\sqrt{3}$, that is $\kappa'_3 = 2 \cdot \frac{4\pi}{9\sqrt{3}} + 2 \cdot \int_0^{1/\sqrt{3}} \pi(1-t^2)dt = \frac{14\pi}{9\sqrt{3}}$ and

$$\lambda_3 \leq 20 \cdot 3\sqrt{3} \cdot (9\sqrt{3})/(24\pi) = 5 \cdot 27/4\pi = 10.74295\dots$$

By Makai's conjecture [104], λ_n is as it should be for simplex, i.e.

$$\lambda_n = \frac{n!2^{n/2}}{\sqrt{n+1}}, \lambda_3 = 6\sqrt{2} = 8.4852\dots \quad (\text{A.4})$$

And for centro-symmetric bodies, λ'_n should be as it is for the cross-polytopes, i.e. $\lambda'_n = n!$.

A.1.3 Estimation of δ_n

The constant δ_3 (best ball packing in three-space) is known³ to be $\pi/\sqrt{18}$ (Kepler conjecture). This was proved for lattice packings by Gauss(1831)[46]. For four dimensions the densest lattice packing has $\delta_4 = \pi^2/16$, by Korkine and Zolotareff (1872). Densest lattices are known up to dim 8.

Proposition A.1.10. For a compact convex body $D \subset \mathbb{R}^3$ the inequality $\text{Volume}(D) \geq c_3\omega(D)^3$ holds with $c_3 = 0.0658$.

Proof. We recall the flow of the estimates. It follows from Lemma A.1.2, that the optimal constant c_3 in the considered inequality is at least the volume of a convex compact body $D' \subset \mathbb{R}^3$ such that the lattice $\mathbb{Z}^3 + D'$ of translates of D' by \mathbb{Z}^3 is non-separable. Then, by Lemma A.1.3 we only need to find the constant $\delta_3(E)$ and the volume of E where $E = (\frac{D-D}{2})^*/4$. Instead, we replace D by a ball, at some cost, see Proposition A.1.6. We know κ_3 by Remark A.1.5. The constant λ_3 is found in Lemma A.1.9.

Hence, in three dimensional case, $\rho(D) \geq \frac{\kappa_3}{2^3\lambda_3\delta_3} = \frac{\frac{2^2\pi}{3}}{2^3 \cdot 5 \cdot 27/4\pi \cdot \pi/\sqrt{18}} = \frac{2\pi\sqrt{18}}{3 \cdot 5 \cdot 27} = 0.06582\dots$ whereas the conjectured value is $1/12$. \square

A.1.4 The approach by Mahler's conjecture

There is another approach to (A.1): we put $\delta = 1$ and use the Mahler conjecture. Namely, for an origin-symmetric K we define $K^o = \{x | \sup_{y \in K} \langle xy \rangle \leq 1\}$.

² $C_{2n}^n = \binom{2n}{n}$

³It is known only by computer computations, a formal proof of the correctness of the algorithm announced in [71]

Mahler in 1939 proves that

$$\frac{4^n}{(n!)^2} \leq \text{Volume}(K)\text{Volume}(K^o) \leq 4^n.$$

Then he conjectured that

$$\frac{4^n}{n!} \leq \text{Volume}(K)\text{Volume}(K^o) \leq \frac{\pi^n}{\Gamma(\frac{n}{2} + 1)^2}.$$

The right hand side was proved by Santaló in 1949, and the equality is attained on ellipsoids. Define *Santaló point* as such a point, that if we choose it as the origin, then we get the minimal value of $\text{Volume}(K)\text{Volume}(K^o)$ for a given K . One can prove that the extremal cases are ellipsoids using the fact that this point is unique. The left part is not proven yet, though the progress is quite significant.

Bourgain and Milman in 1987 proved that there exists a constant c such that

$$c^n \frac{4^n}{n!} \leq \text{Volume}(K)\text{Volume}(K^o).$$

In [139] it is proven that the extremal cases in this inequality are polytope-like, i.e. they contain no points with positive Gauss curvature. Mahler conjectured that the minimum in this class is attained for the cube and its polar body, the cross-polytope. If this is true, then the minimum would also be attained by mixtures of the cube and the cross-polytope, etc; thus, in the class of centrally symmetric convex bodies the minimum is attained not for a unique convex body (up to affine transforms). See [25] for more details about developments of this area.

Kuperberg [95] proved Mahler conjecture up to factor $(\pi/4)^n \gamma_n$, where γ_n starts from $4/\pi$ and converges to $\sqrt{2}$. Therefore for $n = 3$ for central symmetric it gives $(\pi/4)^2 = 0.61685025$ what is very good. Also he proved $\text{Volume}(K)\text{Volume}(K^o) \geq \frac{2^n (n!)^2}{(2n)!} \cdot \kappa_n^2 = 0.4 \cdot (4\pi/3)^2 = 7.02\dots$ for $n = 3$, for centrally symmetric bodies.

A.2 Estimation of area in terms of lattice width

This section is devoted to the following theorem:

Theorem A.2.1. *Let $A \subset \mathbb{Z}^2$ be a convex polygon. Suppose $\min_{u \in \mathbb{Z}^2, u \neq (0,0)} (\max_{x,y \in A} u \cdot (x - y)) = a$. Then*

$$\text{area}(A) \geq \frac{3}{8}a^2.$$

Note that we proved this theorem as a particular case of Lemma 1.8.2, see Corollary 1.8.16. Nevertheless, for completeness, we write the details of the proof. The idea is borrowed from [18, 59], we expect that the same idea works in three-dimensional case where the current estimate is not optimal.

Lemma A.2.2. *Consider an acute-angled plane triangle with all altitudes at most d . Then its area is at most $\frac{1}{\sqrt{3}}d^2$.*

Proof. One of the angles between the altitudes and the sides of the triangle is at most $\pi/6$, therefore one of the sides of the triangle is at most $\frac{1}{\sin \frac{\pi}{6}}d$. This implies that its area is at most $\frac{1}{2\sin \frac{\pi}{6}}d^2 = \frac{1}{\sqrt{3}}d^2$. \square

Remark A.2.3. Equality is obtained only in the case of an equilateral triangle.

Denote by $\text{area}(F)$ the area and by $d(F)$ the diameter of a planar convex figure F . Let Aff be the group of area-preserving affine transformations of \mathbb{R}^2 . Among all affine images of a planar convex figure A of non-zero area, we choose a figure F on which the maximum $\max_{f \in Aff} \text{area}(f(A))/d(f(A))^2$ is attained. Such a figure definitely exists because if $f \in Aff$ is very far from $Id \in Aff$, then $\text{area}(f(A))/d(f(A))^2$ is close to zero.

Lemma A.2.4. The figure F has at least two diameters with acute angle of at least $\pi/4$ between them.

Proof. Pick a diameter D of F . Let us try to squeeze F a bit in the direction of D and stretch it out in the perpendicular direction, while preserving the area. Since $\max(\text{area}/d^2)$ is attained for the figure F , this action increases the other diameter of F , call it D' , and the angle between D and D' is at least $\pi/4$ because D' increases when we squeeze F in such a way. \square

Hence we could suppose from the beginning that D and D' are two diameters of F with the maximal acute angle between them among all pairs of diameters of F .

Lemma A.2.5. There are two diameters of F with the acute angle at least $\pi/3$ between them.

Proof. Suppose that this angle is less than $\pi/3$. In the notation of the previous lemma, we attempt to perform an affine shift, parallel to D and decreasing D' . It should increase some other diameter, call it D'' . Recall that the acute angle between D'' and D' is less than that between D and D' . The same is true for the acute angle between D and D'' as well. Now it is easy to check that either the angle between D and D'' or between D' and D'' is at least $\pi/3$. \square

Corollary A.2.6. Any convex compact set $A \subset \mathbb{R}^2$ can be transformed by an affine map f in such a way that its image $f(A)$ satisfies $\sqrt{3}D^2 \leq 4S$, where D is the diameter of $f(A)$ and S is the area of $f(A)$.

Proof. The above lemma implies that $\text{area}(F) \geq \frac{1}{2} \sin \frac{\pi}{3} d(F)^2$ and F is an affine transformation of A . \square

Article [59] uses this fact and cites [18] for a proof. The latter is in German, I'm not sure that the above proof represents a correct translation from German, probably, this is another proof.

Remark A.2.7. The extremal cases are convex hulls of two intervals of equal lengths with an angle of $\pi/3$ between them.

Let us notice some additional properties of lattice width.

Remark A.2.8. Recall that the usual width of a convex planar figure A in a direction $(r, q) \in \mathbb{Z}^2$ is the length of the projection of A to a line in the direction (r, q) . Suppose that $\gcd(r, q) = 1$. Apply an affine transformation $\psi : \mathbb{Z}^2 \rightarrow \mathbb{Z}^2$ which brings (r, q) to $(1, 0)$. Usual width of $\psi(B)$ in the direction $(1, 0)$ is equal to $\omega_{(r, q)}(B)$. There is another way to compute lattice width: one can evaluate the usual width w of B in the direction (r, q) . In this case $\omega_{(r, q)}(B) = w \cdot \sqrt{r^2 + q^2}$.

One can notice that lattice width is a *lattice-dependent* property, but now we will reformulate this notion in purely affine terms. Suppose that the minimal lattice width $\omega(A)$ of the figure A is equal to a .

Denote by $a\mathbb{Z}^2$ a sublattice of \mathbb{Z}^2 generated by two vectors $(a, 0)$ and $(0, a)$.

Lemma A.2.9. Consider all translations of A by $a\mathbb{Z}^2$. Each line in the plane intersects at least one of the images of A .

Proof. Suppose there is a line l which intersects no image of A . Let $a\mathbb{Z}^2(l)$ be the set of all translations of the line l by elements of $a\mathbb{Z}^2$. If the slope of l is irrational, then $a\mathbb{Z}^2(l)$ is everywhere dense, so it intersects A . If the slope is rational, then $a\mathbb{Z}^2(l)$ slices the parallelogram in strips of lattice width a in the direction perpendicular to l . A must be inside a strip, so its lattice width is less than a . We arrived at a contradiction. \square

Proof of Theorem A.2.1. Now consider a lattice as described in the lemma above. By the above corollary, we can apply an area-preserving affine transformation f in order to have $F = f(A)$, such that $\text{area}(F) \geq \frac{\sqrt{3}}{4}d(F)^2$.

Consider the smallest acute-angled triangle in the lattice $f(a\mathbb{Z}^2)$. All altitudes of the triangle are less than or equal to the diameter $d(F)$, because for each line l (choose the directions of the sides of such a triangle) the set $a\mathbb{Z}^2(l)$ intersects F . Hence the area $a^2/2 = \omega^2/2$ of the triangle is at most $d(F)^2/\sqrt{3} \leq 4 \cdot \text{area}(F)/3$. Therefore $\frac{a^2}{2} \leq 4 \cdot \text{area}(F)/3 = 4 \cdot \text{area}(A)/3$, which finishes the proof of the theorem. \square

Remark A.2.10. Let us find the cases where the inequality $\text{area}(A) \geq \frac{3}{8}a^2$ is extremal. Looking at the extremal cases of auxiliary inequalities, one can see that for even a , the extremal case is the triangle with vertices $(0, 0)$, $(a/2, -a)$, $(a, -a/2)$. Indeed, the acute-angled triangle of the lattice must be equilateral with sides of length a and the widths of F in the directions of the sides of the triangle must be equal to a . Therefore A is equilateral. Passing to the standard lattice, one gets exactly the triangle $(0, 0)$, $(a/2, -a)$, $(a, -a/2)$ which is a lattice triangle if a is even.

In Corollary 1.8.16 we found extremal cases also for all odd a . It seems that we can repeat the same arguments in \mathbb{R}^3 .

Question 23. What is the best constant in the analog of Corollary A.2.6 in the three-dimensional case? We might repeat all the arguments with squeezing the diameters. It is relatively easy to find four diameters in a kind of extremal positions, but if we believe that the answer will be the equilateral tetrahedron, then we need to work with 6 diameters. Also, estimations of the volume in each case is straightforward but rather tedious. So, we can formulate the problem as follows. For a given set of 4 (or 5, or 6...) equal intervals in \mathbb{R}^3 , we need to estimate the volume of their convex hull, if we know the directions of the intervals. Then, we need to understand when there exists an

infinitesimal affine volume-preserving map, which do not increase the lengths in the directions of the intervals and decrease it for at least one of their directions.

Appendix B

Applications of tropical geometry: economics

A caution: this whole chapter presents only my personal opinion, and should not be taken as some well-argued judgement.

Tropical geometry, it is said, is being used outside of algebraic geometry. Despite claiming applications in computational biology and chemistry [125, 130], it seems that these articles need nothing except tropical semi-ring and a bit of polytope theory, or only a logarithmic limit (without any geometry after that). In sandpile models one obtains tropical curves as the thermodynamical limit [37], and similar picture one can find in soliton waves [92]. All that means: tropical objects had already been found with different circumstances, but have not yet been appropriately treated, with the available tools.

Still, inspired by phylogenetic trees, one can pose some toric geometry questions [57]. Tropical computations are themselves a large area of research, see software package Gfan (<http://home.imf.au.dk/jensen/software/gfan/gfan.html>) and [22]. Some physicist recently have used tropical geometry in order to speed up their computations [72]. In algebraic geometry the following applications are worth mentioning: [137] uses tropical intersection theory for finding a group in a p-adic context: the author, namely, estimates the valuations of the common roots of a system of equations; in [66] a positive Haar measure on a tropical variety is constructed, for future use in a proof of a Bogomolov conjecture over a functional field. The study of ultradiscretization of integrable systems (see a survey [126] and references therein) also appears to be of some interest.

However, from my point of view, the most outstanding application of tropical geometry (outside of classical algebraic geometry, where it is counting of curves [116], universal polynomial [9], and estimates of how many rational points a curve with small Mordell rank contains [83]) appears to be in economics. This chapter contains the key ideas of the article [14], that was written for economists and is hardly readable for mathematicians¹. Possibly, the following text will be interesting for mathematicians — I did my best to keep economical notions both true and understandable. Later, the article [157] appeared, it contains much more detailed discussion about this economical stuff, references, etc.

¹because (à cause de) some simple mathematical proofs are written in dozens of pages, mixed with economical examples and terminology which do not belong to mathematics

B.1 Theses about Economics.

Here I should explain some underlying ideas (in bold) which a mathematician must understand before reading these particular economical articles. It is important to note that this chapter had been written just after the reading and reflecting on [14], before explanations from the authors and appearance of [157].

1. Economics is a *science*². Hence, given a situation, we invent a model, then, after a time, when someone finds that this model does not work under some conditions, we add complimentary explanations, and refine this model. This process frequently leads to new ideas and methods. Also, life demands new inventions: in this case The Bank of England had to inflate the society with money.

So, when we look at all this economical gear, it is a kind of the world's first derivative, explication of *observable variables*³ in formal terms.

2. We (*mathematicians*) need to understand economical jargon and ideas behind it, when we read articles, without knowing the history of economical notions, motivations, etc. Therefore, the result is a kind of second derivative of the real world. So, do not expect it to be logical or concise.

3. The main economical belief : **each thing has a true price**. For example, a king buys silver. If this silver is relatively easy to mine, then price will fall down, except if there is a monopolist who seized all the mines. But he needs money for protecting himself and silver mines from aggressors and thieves. The final price accumulates all this complicated story: risk to be killed, guard's salary, bribes, etc. So, the price is a perfect bureaucratic number — characterizing everything at once. One should distinguish the true price (*intrinsic value*) which is hard to calculate, and *market value* which can be much easily approached⁴ on a market and can be considered as a good estimate of intrinsic value, if this market is functioning good enough.

4. For stability of the social (i.e. economical) life **it is really important that most market prices are actually true prices**. The global world financial crisis 2007–2008 happened because of *real estate bubble*, and a *bubble* always means that something is sold with price much higher than it should be. Suppose you sell an insurance for a bank deposit, which is about some assurance for a company that someone returns his credit in time. It is really hard to estimate the true price of such a thing, for the reason that it mostly consists of expectations about future. Therefore a lot of economists try to develop a procedure to find the true price for such things. We can not avoid *credits*, seeing them as the one of the tools to “warm up” the economics. Simplified: quicker the money move in a society, quicker is the development of the economy.

5. **A market may have or have not equilibrium**. An equilibrium means that all participants (*agents*) sell and buy by prices, which are locally optimal for them. Optimality touches the other economical belief: **A lot of economical set-ups can be modeled by means of objective functions which indicate “happiness” of agents and all agents try to increase it**. Here the tropical geometry come on the scene: by [111] a common person considers only two operations, addition and maximum (recall that these operations give the tropical semi-ring). Remember yourself in a shop: while you do only these two operations, everything is ok, but when you encounter

²and mathematics *is not*. New paradigms do not contradict the previous ones; no experiments. Mathematics is the *language*, underlying the reality

³I like the idea that since economists start to measure a quantity, it immediately changes because politics want to improve it.

⁴go to the Bazaar in Istanbul

two products such that the first is better but its price is higher, you have problems. So, in first approximation we use only piecewise linear functions.

6. **Markets without equilibrium are unstable:** a person with crucial information may always earn a lot of money at the expense of others; finally that will crash this market.

7. If there are many equilibriums, it is also bad, after a fluctuations a market can switch to other equilibrium and some other markets, depended of the considered, will be destroyed⁵.

8. What is the best way to find the true price? **In most cases, it is auctions.** Then, given a concrete situation (e.g. you need to sell expectation), an economist firstly formalize it in terms of agents, goods, prices, objective functions, and then he tries to build a model of auction which can be proven to have a unique equilibrium.

9. The hard thing to understand for mathematicians is that economics is primarily a *practical science*, but with a very restricted possibility to do experiments⁶. First of all we need to explain some phenomena, which occur in real world, or invent a procedure with a desired result, for what we need to know which parameters to control and how. Frequently there are additional restrictions: here, for example, it was better to have only one round of the auction.

In the discussed article, tropical geometry came on the scene as a formalization of what has been done. So, it is better to say that it is not an application of tropical geometry, but tropical geometry emerges from *Product-Mix auctions*. The set-up was the following: the Bank of England wanted to give credits for a given sum (in order to warm up the economics). A credit can be given on the security⁷ of estate (*strong collateral*) or something else (*weak collateral*). It is more safe to use only strong collaterals, but The Bank wanted to give more money than the players can secure by estate. Therefore the auction is about who and with which interest rates will obtain credits.

The advantages of the auctions proposed in [89] is the following: the procedure allows to choose the amount of buying goods (*the sum of the credit*) after the final price (*percentage rate for the credit*) is released. Bank knows the demand of agents before releasing prices. As in many cases, the information is the most expensive resource and here there is a balance between what is known and what is not known.

While generalizing this algorithm to more than two goods (strong and weak collaterals), the authors have rediscovered the features of tropical geometry, see [14].

B.2 Application of tropical geometry for auctions

As we state in the previous section, the auctions provide one of the best instruments for determining the true price. Nevertheless, it is better to have an auction which always has an equilibrium. More or less clear that an auction, where participants sell and buy not just one good, but the sets (*bundles* in economical jargon) of different goods, is more stable because it accumulates information about different things at once. For example, one can buy a set which consists of an amount of stable investments with low outcome and an amount of risky investments with big possible outcome.

⁵moreover, it is not clear what is a true price in this case

⁶so, it is better to read economists who consult a government or a big enterprise

⁷You loose your estate if you don't pay, and if the price of this estate decreases, you must give to the bank the difference, which "secures" your credit. Because of this dangerous situation, sometimes, it is not profitable to borrow a credit even with *negative* interest rate

Here we see that piecewise geometry comes in. I only intend to describe important things to know when reading [14], and forward the reader for all the details there.

Definition B.2.1. We have sets $I_p = (i_{1p}, i_{2p}, \dots, i_{np})$ (*bundles*) $p = 1, \dots, n$ of *indivisible* goods and for each set we have a number a_{I_p} (*indicates the happiness of a person if she buys it*). Then the objection function of this person becomes $f_x(c_1, \dots, c_j) = \max_{p=1, \dots, n} (a_{I_p} + \sum c_j i_{jp})$ where c_j is the minus price of j -th good and x is the number of a person. For given c_1, c_2, \dots the person x buys the bundle I_p where f_x attains its maximum.

Then a bank can state which sets I_p are possible for trading and then we can ask whether there always exist an equilibrium or not. **Always** means here that for any bundle B that the bank wants to distribute, there are prices for goods such that all customers maximize their objective functions and B is completely sold.

It happened that the most natural form of answer came in terms of tropical geometry, and it is surprisingly easy to formulate and prove.

Proposition B.2.2. If all the intersections of the tropical hypersurfaces f_x , defined by the objective function (Definition B.2.1) of all persons, are transversal, then for each collections of goods there is an equilibrium.

A proof is very straightforward. Take a point of non-transversal intersection of the objective function, it defines prices c_1, c_2, \dots . Non-transversality is equivalent to the fact that in the polygon, dual to this intersection, there is an integer point inside. Taking it as the proposed bundle B we fail to find an equilibrium. \square

Also we can comment about the jargon: the Newton polygon of f_x lives in *quantity space*, the hypersurface defined by f_x lives in *price space*.

From the economical perspective the above discussion is important because prior this article, the economists always distinguished between *substitutes* (I can buy A instead of B) and complements (if I buy A, then I also tend to buy B).

Now, using tropical geometry, we see that really we are interested in the possible directions of faces of the tropical surface defined by f_x , and we seek for some kind of unimodularity of sets of edges in the Newton polygons of f_x . Edges in the Newton polygon, which are dual to the faces of f_x are called *vectors in the demand space*.

Claim: We should permit only such a functions f_x , that the intersections of the tropical surfaces defined by f_x are always transverse. That means that the edges in the Newton polytopes of f_x belong to an unimodular lattice.

Finally we can ask some questions like: how many such a unimodular lattices exist?

The classification, in terms of “building blocks” of such lattices is obtained in [48] (using the ideas of [147]). Somewhat similar approach (without real-world implementations) has been earlier proposed by Danilov and Koshevoy ([49]), but they lack identifying economical jargon and some simple equivalences.

Bibliography

- [1] O. B. Ader. An affine invariant of convex regions. *Duke Math. J.*, 4(2):291–299, 1938. (page 113).
- [2] A. Alarcón and F. Forstnerič. Null curves and directed immersions of open riemann surfaces. *Inventiones mathematicae*, 196(3):733–771, 2014. (page 84).
- [3] J. Alexander and A. Hirschowitz. Polynomial interpolation in several variables. *J. Algebraic Geom.*, 4(2):201–222, 1995. (page 44).
- [4] J. Alexander and A. Hirschowitz. An asymptotic vanishing theorem for generic unions of multiple points. *Inventiones mathematicae*, 140(2):303–325, 2000. (page 45).
- [5] O. Amini, M. Baker, E. Brugallé, and J. Rabinoff. Lifting harmonic morphisms I: metrized complexes and Berkovich skeleta. *Res. Math. Sci.*, 2:2:7, 2015. (page 80).
- [6] O. Amini, M. Baker, E. Brugallé, and J. Rabinoff. Lifting harmonic morphisms II: Tropical curves and metrized complexes. *Algebra Number Theory*, 9(2):267–315, 2015. (page 80).
- [7] E. S. C. Amorim. Curvas de contato no espaço projetivo. *Tese*. (page 84).
- [8] M. Angelica Cueto and H. Markwig. How to repair tropicalizations of plane curves using modifications. *ArXiv e-prints*, Sept. 2014. (pages 55, 60).
- [9] F. Ardila and F. Block. Universal polynomials for severi degrees of toric surfaces. *Advances in Mathematics*, 237:165–193, 2013. (page 120).
- [10] F. Ardila and C. J. Klivans. The Bergman complex of a matroid and phylogenetic trees. *J. Combin. Theory Ser. B*, 96(1):38–49, 2006. (pages 8, 20).
- [11] J. C. Artés, J. Llibre, and N. Vulpe. Quadratic systems with a polynomial first integral: A complete classification in the coefficient space \mathbb{R}^{12} . *J. Differ. Equations*, 246(9):3535–3558, 2009. (page 90).
- [12] M. Baker. An introduction to berkovich analytic spaces and non-archimedean potential theory on curves. *p-adic Geometry (Lectures from the 2007 Arizona Winter School)*, 2008. (page 60).
- [13] M. Baker, S. Payne, and J. Rabinoff. Nonarchimedean geometry, tropicalization, and metrics on curves. *ArXiv e-prints*, Apr. 2011. (pages 57, 60).

- [14] E. Baldwin and P. Klemperer. Tropical geometry to analyse demand. (pages 120, 121, 122, 123).
- [15] I. Bárány and Z. Füredi. On the lattice diameter of a convex polygon. *Discrete Math.*, 241(1-3):41–50, 2001. (page 15).
- [16] M. Beck. *Integer Points in Polyhedra— Geometry, Number Theory, Representation Theory, Algebra, Optimization, Statistics: AMS-IMS-SIAM Joint Summer Research Conference, June 11-15, 2006, Snowbird, Utah*. Contemporary mathematics - American Mathematical Society. American Mathematical Society, 2008. (page 112).
- [17] M. Beck and S. Robins. Computing the continuous discretely, undergraduate texts in mathematics, 2007. (page 112).
- [18] F. Behrend. Über einige Affininvarianten konvexer Bereiche. *Math. Ann.*, 113(1):713–747, 1937. (pages 32, 116, 117).
- [19] B. Bertrand, E. Brugallé, and G. Mikhalkin. Tropical open Hurwitz numbers. *Rend. Semin. Mat. Univ. Padova*, 125:157–171, 2011. (page 80).
- [20] B. Bertrand, L. L. de Medrano, and J.-J. Risler. On the total curvature of tropical hypersurfaces. 03 2013. (page 112).
- [21] C. Bocci. Special effect varieties in higher dimension. *Collect. Math.*, 56(3):299–326, 2005. (page 44).
- [22] T. Bogart, A. Jensen, D. Speyer, B. Sturmfels, and R. Thomas. Computing Tropical Varieties. *ArXiv Mathematics e-prints*, July 2005. (page 120).
- [23] J. Bolton and L. Fernandez. Regularity of the space of harmonic 2-spheres in the unit 4-spheres. Ohnita, Yoshihiro (ed.) et al., Riemann surfaces, harmonic maps and visualization. Proceedings of the 16th Osaka City University International Academic Symposium, Osaka, Japan, December 15–20, 2008. Osaka: Osaka Municipal Universities Press. OCAMI Studies 3, 119-128 (2010)., 2010. (page 85).
- [24] J. Bolton and L. M. Woodward. The space of harmonic two-spheres in the unit four-sphere. (page 85).
- [25] K. J. Böröczky, E. Makai, Jr., M. Meyer, and S. Reisner. On the volume product of planar polar convex bodies—lower estimates with stability. *Studia Sci. Math. Hungar.*, 50(2):159–198, 2013. (page 116).
- [26] B. H. Bowditch and D. B. A. Epstein. Natural triangulations associated to a surface. *Topology*, 27(1):91–117, 1988. (page 59).
- [27] S. Brendle. Minimal surfaces in S^3 : a survey of recent results. *Bull. Math. Sci.*, 3(1):133–171, 2013. (page 84).

- [28] M. Brion. Piecewise polynomial functions, convex polytopes and enumerative geometry. In *Parameter spaces (Warsaw, 1994)*, volume 36 of *Banach Center Publ.*, pages 25–44. Polish Acad. Sci., Warsaw, 1996. (page 47).
- [29] E. Brugallé, I. Itenberg, G. Mikhalkin, and K. Shaw. Brief introduction to tropical geometry. *Proceedings of 21st Gökova Geometry-Topology Conference*, arXiv:1502.05950, 2015. (pages 8, 13, 45, 51, 55, 57, 85).
- [30] E. Brugallé and G. Mikhalkin. Enumeration of curves via floor diagrams. *C. R. Math. Acad. Sci. Paris*, 345(6):329–334, 2007. (page 42).
- [31] E. Brugallé and G. Mikhalkin. Floor decompositions of tropical curves: the planar case. In *Proceedings of Gökova Geometry-Topology Conference 2008*, pages 64–90. Gökova Geometry/Topology Conference (GGT), Gökova, 2009. (pages 42, 51).
- [32] E. Brugallé and K. Shaw. A bit of tropical geometry. *ArXiv e-prints*, Nov. 2013. (pages 55, 85).
- [33] E. A. Brugallé and L. M. López de Medrano. Inflection points of real and tropical plane curves. *J. Singul.*, 4:74–103, 2012. (pages 8, 11, 55, 58, 70, 73, 78, 80).
- [34] R. L. Bryant. Conformal and minimal immersions of compact surfaces into the 4-sphere. *J. Differential Geom.*, 17(3):357–521, 1982. (page 84).
- [35] J. Buczyński. Algebraic Legendrian varieties. *Dissertationes Math. (Rozprawy Mat.)*, 467:86, 2009. (page 85).
- [36] P. Buser. The collar theorem and examples. *Manuscripta Math.*, 25(4):349–357, 1978. (page 58).
- [37] S. Caracciolo, G. Paoletti, and A. Sportiello. Conservation laws for strings in the abelian sandpile model. *EPL (Europhysics Letters)*, 90(6):60003, 2010. (page 120).
- [38] W. Castryck. Moving out the edges of a lattice polygon. *Discrete Comput. Geom.*, 47(3):496–518, 2012. (page 112).
- [39] W. Castryck and F. Cools. Newton polygons and curve gonality. *Journal of Algebraic Combinatorics*, 35(3):345–366, 2012. (pages 15, 112).
- [40] A. Chambert-Loir. Heights and measures on analytic spaces. a survey of recent results, and some remarks. 01 2010. (page 112).
- [41] Q.-S. Chi. The dimension of the moduli space of superminimal surfaces of a fixed degree and conformal structure in the 4-sphere. *Tohoku Math. J., II. Ser.*, 52(2):299–308, 2000. (page 85).
- [42] Q.-S. Chi and X. Mo. The moduli space of branched superminimal surfaces of a fixed degree, genus and conformal structure in the four-sphere. *Osaka J. Math.*, 33(3):669–696, 1996. (page 85).

- [43] C. Ciliberto. Geometric aspects of polynomial interpolation in more variables and of Waring’s problem. In *European Congress of Mathematics, Vol. I (Barcelona, 2000)*, volume 201 of *Progr. Math.*, pages 289–316. Birkhäuser, Basel, 2001. (page 44).
- [44] C. Ciliberto, B. Harbourne, R. Miranda, and J. Roé. Variations of Nagata’s conjecture. In *A celebration of algebraic geometry*, volume 18 of *Clay Math. Proc.*, pages 185–203. Amer. Math. Soc., Providence, RI, 2013. (page 44).
- [45] C. Ciliberto and R. Miranda. Homogeneous interpolation on ten points. *J. Algebraic Geom.*, 20(4):685–726, 2011. (page 44).
- [46] J. Conway and N. Sloane. *Sphere packings, lattices and groups. With additional contributions by E. Bannai, R. E. Borcherds, J. Leech, S. P. Norton, A. M. Odlyzko, R. A. Parker, L. Queen and B. B. Venkov. 3rd ed.* New York, NY: Springer, 3rd ed. edition, 1999. (pages 113, 115).
- [47] D. Cox, J. Little, and H. Schenck. *Toric Varieties*. Graduate studies in mathematics. American Mathematical Soc., 2011. (page 112).
- [48] V. Danilov and V. Grishukhin. Maximal unimodular systems of vectors. *European Journal of Combinatorics*, 20(6):507 – 526, 1999. (page 123).
- [49] V. Danilov, G. Koshevoy, and K. Murota. Discrete convexity and equilibria in economies with indivisible goods and money. *Mathematical Social Sciences*, 41(3):251–273, 2001. (page 123).
- [50] A. Dickenstein, S. Di Rocco, and R. Piene. Higher order duality and toric embeddings. *Ann. Inst. Fourier*, 64(1):375–400, 2014. (pages 7, 14, 21).
- [51] A. Dickenstein, E. M. Feichtner, and B. Sturmfels. Tropical discriminants. *J. Amer. Math. Soc.*, 20(4):1111–1133, 2007. (pages 7, 14, 20).
- [52] A. Dickenstein and L. F. Tabera. Singular tropical hypersurfaces. *Discrete Comput. Geom.*, 47(2):430–453, 2012. (pages 7, 10, 14, 20).
- [53] N. Do. *Intersection theory on moduli spaces of curves via hyperbolic geometry*. PhD thesis, Ph. D. Thesis, University of Melbourne, 2008. (page 59).
- [54] J. Draisma, T. B. McAllister, and B. Nill. Lattice-width directions and Minkowski’s 3^d -theorem. *SIAM J. Discrete Math.*, 26(3):1104–1107, 2012. (page 113).
- [55] M. Dumnicki, B. Harbourne, T. Szemberg, and H. Tutaj-Gasińska. Linear subspaces, symbolic powers and Nagata type conjectures. *Adv. Math.*, 252:471–491, 2014. (page 44).
- [56] M. Einsiedler, M. Kapranov, and D. Lind. Non-Archimedean amoebas and tropical varieties. *J. Reine Angew. Math.*, 601:139–157, 2006. (page 11).
- [57] N. Eriksson, K. Ranestad, B. Sturmfels, and S. Sullivant. Phylogenetic Algebraic Geometry. *ArXiv Mathematics e-prints*, July 2004. (page 120).

- [58] L. Evain. Computing limit linear series with infinitesimal methods. *Ann. Inst. Fourier (Grenoble)*, 57(6):1947–1974, 2007. (page 42).
- [59] L. Fejes Tóth and E. Makai, Jr. On the thinnest non-separable lattice of convex plates. *Stud. Sci. Math. Hungar.*, 9:191–193 (1975), 1974. (pages 32, 116, 117).
- [60] V. Ferrer and I. Vainsencher. Polynomial vector fields with algebraic trajectories. In *Commutative algebra and its connections to geometry. Pan-American Advanced Studies Institute (PASI), Universidade Federal de Pernambuco, Olinda, Brazil, August 3–14, 2009.*, pages 71–85. Providence, RI: American Mathematical Society (AMS), 2011. (page 90).
- [61] A. Fink. Tropical cycles and Chow polytopes. *Beitr. Algebra Geom.*, 54(1):13–40, 2013. (page 50).
- [62] S. Friedl and T. Kim. Twisted Alexander norms give lower bounds on the Thurston norm. *Trans. Amer. Math. Soc.*, 360(9):4597–4618, 2008. (page 15).
- [63] Y. Ganor. *Enumerating Cuspidal Curves on Toric Surfaces*. Tel Aviv University, 2013. (page 8).
- [64] I. Gelfand, M. Kapranov, and A. Zelevinsky. Discriminants, resultants and multidimensional determinants, 1994. *Birkhäuser, Boston Zbl0827*, 14036. (page 7).
- [65] Y. L. Giluch. A real analogue of the bryant transformation and rational integral curves of a given distribution in \mathbb{P}^3 . *Izvestiya Vysshikh Uchebnykh Zavedenii. Matematika*, (6):76–81, 2005. (page 85).
- [66] W. Gubler. Tropical varieties for non-Archimedean analytic spaces. *Invent. Math.*, 169(2):321–376, 2007. (page 120).
- [67] W. Gubler, J. Rabinoff, and A. Werner. Skeletons and tropicalizations. 04 2014. (page 57).
- [68] W. Gubler, J. Rabinoff, and A. Werner. Tropical skeletons. 08 2015. (page 57).
- [69] W. Habicht. Über die Lösbarkeit gewisser algebraischer Gleichungssysteme. *Comment. Math. Helv.*, 18:154–175, 1946. (page 85).
- [70] M. Hakan Gunturkun and A. Ulas Ozgur Kisisel. Using Tropical Degenerations For Proving The Nonexistence Of Certain Nets. *ArXiv e-prints*, July 2011. (page 81).
- [71] T. Hales, M. Adams, G. Bauer, D. T. Dang, J. Harrison, T. L. Hoang, C. Kaliszyk, V. Margron, S. McLaughlin, T. T. Nguyen, T. Q. Nguyen, T. Nipkow, S. Obua, J. Pleso, J. Rute, A. Solovyev, A. H. T. Ta, T. N. Tran, D. T. Trieu, J. Urban, K. K. Vu, and R. Zumkeller. A formal proof of the kepler conjecture. 01 2015. (page 115).
- [72] M. Hampton and A. Jensen. Finiteness of spatial central configurations in the five-body problem. *Celestial Mechanics and Dynamical Astronomy*, 109(4):321–332, 2011. (page 120).
- [73] S. H. Hansen. Error-correcting codes from higher-dimensional varieties. *Finite fields and their applications*, 7(4):530–552, 2001. (page 54).

- [74] B. Harbourne. Problems and progress: a survey on fat points in \mathbb{P}^2 . In *Zero-dimensional schemes and applications (Naples, 2000)*, volume 123 of *Queen's Papers in Pure and Appl. Math.*, pages 85–132. Queen's Univ., Kingston, ON, 2002. (page 44).
- [75] R. Hartshorne. Varieties of small codimension in projective space. *Bull. Amer. Math. Soc.*, 80:1017–1032, 1974. (page 50).
- [76] E. Hrushovski. Imaginaries and definable types in algebraically closed valued fields. 03 2014. (page 62).
- [77] I. Itenberg. Introduction á la géométrie tropicale, lectures. (page 8).
- [78] I. Itenberg, G. Mikhalkin, and E. Shustin. *Tropical algebraic geometry*, volume 35 of *Oberwolfach Seminars*. Birkhäuser Verlag, Basel, second edition, 2009. (pages 8, 13, 60).
- [79] L. F. J. Bolton and J. Wood. Some recent developments in the study of minimal 2-spheres in spheres. (page 85).
- [80] N. Kalinin. Tropical approach to Nagata's conjecture in positive characteristic. *arXiv:1310.6684*, Oct. 2013. (pages 4, 81).
- [81] N. Kalinin. The Newton polygon of a planar singular curve and its subdivision. *Journal of Combinatorial Theory, Series A*, 137:226 – 256, 2016. (pages 4, 7, 42, 49, 58, 66, 70, 81).
- [82] R. Kannan and L. Lovász. Covering minima and lattice-point-free convex bodies. *Ann. of Math. (2)*, 128(3):577–602, 1988. (page 113).
- [83] E. Katz, J. Rabinoff, and D. Zureick-Brown. Uniform bounds for the number of rational points on curves of small mordell–weil rank. *arXiv preprint arXiv:1504.00694*, 2015. (pages 50, 120).
- [84] H. J. Keisler. *Foundations of infinitesimal calculus*, volume 20. Prindle, Weber & Schmidt Boston, 1976. (page 60).
- [85] M. Kerber and H. Markwig. Intersecting Psi-classes on tropical $\mathfrak{M}_{0,n}$. *Int. Math. Res. Not. IMRN*, (2):221–240, 2009. (page 59).
- [86] A. Khovanskii. Logarithmic functional and the weil reciprocity laws. In *Proceedings of the Waterloo Workshop on Computer Algebra*, pages 85–108. World Scientific, 2006. (page 71).
- [87] A. Khovanskii. *Logarithmic functional and reciprocity laws*. Amer Math Soc, 2008. (page 71).
- [88] A. G. Khovanskii. Newton polygons, curves on torus surfaces, and the converse weil theorem. *Russian Mathematical Surveys*, 52(6):1251, 1997. (page 71).
- [89] P. Klemperer. The product-mix auction: a new auction design for differentiated goods. *Journal of the European Economic Association*, 8:526–36, 2010. (page 122).
- [90] P. Z. Kobak and B. Loo. Moduli of quaternionic superminimal immersions of 2-spheres into quaternionic projective spaces. *Ann. Global Anal. Geom.*, 16(6):527–541, 1998. (page 85).

- [91] S. Kobayashi. Remarks on complex contact manifolds. *Proceedings of the American Mathematical Society*, 10(1):164–167, 1959. (page 85).
- [92] Y. Kodama and L. K. Williams. Kp solitons, total positivity, and cluster algebras. *Proceedings of the National Academy of Sciences*, 108(22):8984–8989, 2011. (page 120).
- [93] S. Koike, T.-C. Kuo, and L. Paunescu. Non concentration of curvature near singular points of two variable analytic functions, 2012. (page 112).
- [94] M. Kontsevich. Intersection theory on the moduli space of curves and the matrix airy function. *Communications in Mathematical Physics*, 147(1):1–23, 1992. (page 59).
- [95] G. Kuperberg. From the Mahler conjecture to Gauss linking integrals. *Geom. Funct. Anal.*, 18(3):870–892, 2008. (page 116).
- [96] L. Lang. Geometry of tropical curves and application to real algebraic geometry. *ID: unige:43180*, <http://archive-ouverte.unige.ch/unige:43180>, 2014. (pages 58, 110, 111).
- [97] B. Loo. The space of harmonic maps of S^2 into S^4 . *Trans. Am. Math. Soc.*, 313(1):81–102, 1989. (page 85).
- [98] B. Loo. Moduli space of branched superminimal immersions of a compact Riemann surface into S^4 . *J. Aust. Math. Soc., Ser. A*, 66(1):32–50, 1999. (page 85).
- [99] B. E. Lovitts. How to grade a dissertation. *Academe*, 91(6):18–23, 2005. (page 4).
- [100] N. Lubbes and J. Schicho. Lattice polygons and families of curves on rational surfaces. *Journal of Algebraic Combinatorics*, pages 1–24, 2010. (page 112).
- [101] D. Maclagan. Aarms tropical geometry, lectures. page <http://homepages.warwick.ac.uk/staff/D.Maclagan/AARMS/AARMSTropical.pdf>. (page 8).
- [102] D. Maclagan and B. Sturmfels. *Introduction to tropical geometry*, volume 161 of *Graduate Studies in Mathematics*. American Mathematical Society, Providence, RI, 2015. (pages 13, 45).
- [103] F. Madani and M. Nisse. Generalized logarithmic Gauss map and its relation to (co)amoebas. *Math. Nachr.*, 286(14-15):1510–1513, 2013. (page 106).
- [104] E. Makai. On the thinnest non-separable lattice of convex bodies. *Stud. Sci. Math. Hung.*, 13:19–27, 1978. (pages 113, 114, 115).
- [105] M. Makai. any non-transilluminable lattice of balls... (page 113).
- [106] H. Markwig, T. Markwig, and E. Shustin. Tropical curves with a singularity in a fixed point. *Manuscripta Math.*, 137(3-4):383–418, 2012. (pages 8, 10, 22, 40, 58, 66).
- [107] H. Markwig, T. Markwig, and E. Shustin. Tropical surface singularities. *Discrete Comput. Geom.*, 48(4):879–914, 2012. (pages 8, 22, 40, 45, 49).

- [108] H. Markwig, T. Markwig, and E. Shustin. Enumeration of singular tropical surfaces in \mathbb{P}^3 . *arXiv preprint arXiv:1503.08593*, 2015. (page 8).
- [109] T. Markwig. A field of generalised Puiseux series for tropical geometry. *Rend. Semin. Mat. Univ. Politec. Torino*, 68(1):79–92, 2010. (pages 10, 42).
- [110] B. Martin and D. Y. Pochekutov. Discriminant and singularities of logarithmic gauss map, examples and application. *Журнал Сибирского федерального университета. Серия “Математика и физика”*, 6(1):74–85, 2013. (page 106).
- [111] V. Maslov. Tropical mathematics and the financial catastrophe of the 17th century. thermoeconomics of russia in the early 20th century. *Russian Journal of Mathematical Physics*, 17(1):126–140, 2010. (page 121).
- [112] M. Mazin. Geometric theory of Parshin residues. *C. R. Math. Acad. Sci. Soc. R. Can.*, 32(3):81–96, 2010. (page 71).
- [113] R. C. McLean. Deformations and moduli of superminimal surfaces in the four-sphere. *Ann. Global Anal. Geom.*, 15(6):555–569, 1997. (page 85).
- [114] C. T. McMullen. The Alexander polynomial of a 3-manifold and the Thurston norm on cohomology. *Ann. Sci. École Norm. Sup. (4)*, 35(2):153–171, 2002. (page 15).
- [115] W. Meeks and J. Pérez. *A survey on classical minimal surface theory*, volume 60. American Mathematical Soc., 2012. (page 84).
- [116] G. Mikhalkin. Enumerative tropical algebraic geometry in \mathbb{R}^2 . *J. Amer. Math. Soc.*, 18(2):313–377, 2005. (pages 8, 56, 120).
- [117] G. Mikhalkin. Moduli spaces of rational tropical curves. In *Proceedings of Gökova Geometry-Topology Conference 2006*, pages 39–51. Gökova Geometry/Topology Conference (GGT), Gökova, 2007. (pages 56, 59).
- [118] G. Mikhalkin. Quantum indices of real plane curves and refined enumerative geometry. 05 2015. (page 72).
- [119] G. Mikhalkin and G. Mikhalkin. Tropical geometry and its applications, international congress of mathematicians. *Journal of the European Mathematical Society*, Vol. II,:827–852, 2006. (pages 8, 61, 71).
- [120] G. Mikhalkin and I. Zharkov. Tropical curves, their Jacobians and theta functions. In *Curves and abelian varieties*, volume 465 of *Contemp. Math.*, pages 203–230. Amer. Math. Soc., Providence, RI, 2008. (pages 8, 55, 56, 59, 71).
- [121] R. Miranda. Linear systems of plane curves. *Notices AMS*, 46(2):192–202, 1999. (page 44).
- [122] R. Morrison. Tropical images of intersection points. *Collectanea Mathematica*, pages 1–11, 2014. (pages 58, 74).

- [123] E. Musso and L. Nicolodi. On Small-type formulae for curves in $PSL(2, \mathbb{C})$. *Atti Accad. Naz. Lincei Rend. Lincei Mat. Appl.*, 24(3):311–328, 2013. (page 85).
- [124] M. Nagata. On the 14-th problem of Hilbert. *Amer. J. Math.*, 81:766–772, 1959. (page 44).
- [125] V. Noel, D. Grigoriev, S. Vakulenko, and O. Radulescu. Tropical geometries and dynamics of biochemical networks application to hybrid cell cycle models. *Electronic Notes in Theoretical Computer Science*, 284(0):75 – 91, 2012. Proceedings of the 2nd International Workshop on Static Analysis and Systems Biology (SASB 2011). (page 120).
- [126] C. M. Ormerod. Tropical geometric interpretation of ultradiscrete singularity confinement. *J. Phys. A*, 46(30):305204, 15, 2013. (page 120).
- [127] B. Osserman and S. Payne. Lifting tropical intersections. *ArXiv e-prints*, July 2010. (page 57).
- [128] B. Osserman and J. Rabinoff. Lifting non-proper tropical intersections. *ArXiv e-prints*, Sept. 2011. (page 57).
- [129] J. Oxley. What is a matroid. *Cubo Matemática Educacional*, 5(3):179–218, 2003. (page 8).
- [130] L. Pachter and B. Sturmfels. *Algebraic Statistics for Computational Biology*. Cambridge University Press, New York, NY, USA, 2005. (page 120).
- [131] M. Passare and J.-J. Risler. On the curvature of the real amoeba. In *Proceedings of the Gökova Geometry-Topology Conference 2010*, pages 129–134. Int. Press, Somerville, MA, 2011. (page 106).
- [132] S. Paul. New methods for determining speciality of linear systems based at fat points in \mathbb{P}^n . *J. Pure Appl. Algebra*, 217(5):927–945, 2013. (page 44).
- [133] Paul Erdős and P.M. Gruber and J. Hammer. *Lattice points*. Harlow: Longman Scientific & Technical; New York etc: John Wiley & Sons, 1989. (page 113).
- [134] S. Payne. Analytification is the limit of all tropicalizations. *Math. Res. Lett.*, 16(2-3):543–556, 2009. (page 57).
- [135] C. Petty. Surface area of a convex body under affine transformations. *Proceedings of the American Mathematical Society*, 12(5):824–828, 1961. (page 113).
- [136] R. Piene and M. Schlessinger. On the hilbert scheme compactification of the space of twisted cubics. *American Journal of Mathematics*, pages 761–774, 1985. (page 96).
- [137] J. Rabinoff. Higher-level canonical subgroups for p -divisible groups. *J. Inst. Math. Jussieu*, 11(2):363–419, 2012. (page 120).
- [138] J. Rabinoff. Tropical analytic geometry, Newton polygons, and tropical intersections. *Adv. Math.*, 229(6):3192–3255, 2012. (pages 57, 70).

- [139] S. Reisner, C. Schütt, and E. M. Werner. A note on mahler’s conjecture. 09 2010. (page 116).
- [140] Q. Ren, K. Shaw, and B. Sturmfels. Tropicalization of Del Pezzo Surfaces. *ArXiv e-prints*, Feb. 2014. (page 58).
- [141] B. Renschuch. Idealtheoretische Betrachtungen zu Sätzen von Eckmann, Habicht und Chow. *Math. Ann.*, 166:45–53, 1966. (page 85).
- [142] J. Richter-Gebert, B. Sturmfels, and T. Theobald. First steps in tropical geometry. In *Idempotent mathematics and mathematical physics*, volume 377 of *Contemp. Math.*, pages 289–317. Amer. Math. Soc., Providence, RI, 2005. (pages 27, 70).
- [143] J.-J. Risler. On the curvature of the milnor fiber. (page 112).
- [144] C. A. C. A. Rogers. *Packing and covering*, volume 54 of *Cambridge tracts in mathematics and mathematical physics*. 1964. (page 115).
- [145] M. Ruggiero and K. Shaw. Tropical hopf manifolds and contracting germs. *arXiv preprint arXiv:1509.03787*, 2015. (page 58).
- [146] J. M. Ruiz. *The basic theory of power series*. Advanced Lectures in Mathematics. Friedr. Vieweg & Sohn, Braunschweig, 1993. (pages 10, 42).
- [147] P. Seymour. Decomposition of regular matroids. *Journal of Combinatorial Theory, Series B*, 28(3):305 – 359, 1980. (page 123).
- [148] K. Shaw. Tropical surfaces. *ArXiv e-prints*, 06 2015. (pages 55, 58).
- [149] K. M. Shaw. Tropical Intersection Theory and Surfaces, thesis, available online at. <http://archive-ouverte.unige.ch/unige:22758>, 2011. (page 58).
- [150] K. M. Shaw. A tropical intersection product in matroidal fans. *SIAM Journal on Discrete Mathematics*, 27(1):459–491, 2013. (page 57).
- [151] E. Shustin and I. Tyomkin. Patchworking singular algebraic curves. I. *Israel J. Math.*, 151:125–144, 2006. (page 8).
- [152] R. Steffens. Mixed volumes, mixed ehrhart theory and applications to tropical geometry and linkage configurations. 2009. (page 112).
- [153] R. Steffens and T. Theobald. Combinatorics and genus of tropical intersections and Ehrhart theory. *SIAM J. Discrete Math.*, 24(1):17–32, 2010. (page 47).
- [154] L. F. Tabera. The tropical discriminant in positive characteristic. *arXiv preprint arXiv:1403.1051*, 2014. (page 7).
- [155] T. Tao. *Compactness and contradiction*. American Mathematical Society, Providence, RI, 2013. (page 59).

- [156] M. Temkin. Introduction to Berkovich analytic spaces. In *Berkovich spaces and applications*, volume 2119 of *Lecture Notes in Math.*, pages 3–66. Springer, Cham, 2015. (page 60).
- [157] N. M. Tran and J. Yu. Product-mix auctions and tropical geometry. *arXiv preprint arXiv:1505.05737*, 2015. (pages 120, 121).
- [158] M. Tsfasman, S. Vlăduț, and D. Nogin. *Algebraic geometric codes: basic notions*, volume 139 of *Mathematical Surveys and Monographs*. American Mathematical Society, Providence, RI, 2007. (page 53).
- [159] A. Tsygvintsev. Algebraic invariant curves of plane polynomial differential systems. *J. Phys. A, Math. Gen.*, 34(3):663–672, 2001. (page 90).
- [160] I. Tyomkin. On Zariski’s theorem in positive characteristic. *J. Eur. Math. Soc. (JEMS)*, 15(5):1783–1803, 2013. (page 50).
- [161] J.-L. Verdier. Applications harmoniques de S^2 dans S^4 . In *Geometry today (Rome, 1984)*, volume 60 of *Progr. Math.*, pages 267–282. Birkhäuser Boston, Boston, MA, 1985. (page 85).
- [162] J.-L. Verdier. Applications harmoniques de S^2 dans S^4 . II. In *Harmonic mappings, twistors, and σ -models (Luminy, 1986)*, volume 4 of *Adv. Ser. Math. Phys.*, pages 124–147. World Sci. Publishing, Singapore, 1988. (page 85).
- [163] O. Viro. On basic concepts of tropical geometry. *Proceedings of the Steklov Institute of Mathematics*, 273(1):252–282, 2011. (pages 58, 61).
- [164] T. Vlachos. Isometric deformations of minimal surfaces in \mathbb{S}^4 . *Illinois J. Math.*, 58(2):369–380, 2014. (page 84).
- [165] J. Wahl. Nodes on sextic hypersurfaces in \mathbf{P}^3 . *J. Differential Geom.*, 48(3):439–444, 1998. (page 53).
- [166] G. Xu. Curves in \mathbf{P}^2 and symplectic packings. *Math. Ann.*, 299(4):609–613, 1994. (page 44).
- [167] Y.-G. Ye. Complex contact threefolds and their contact curves. (page 85).
- [168] Y.-G. Ye. A note on complex projective threefolds admitting holomorphic contact structures. *Invent. Math.*, 115(2):311–314, 1994. (page 85).
- [169] S. Yoshitomi. Jacobian varieties of reduced tropical curves. (page 72).

*If you are in difficulties with a book,
try the element of surprise: attack it at an hour when it isn’t expecting it.*
Herbert George Wells